



Küba SG industrial





Küba SG industrial: Specific Advantages

The Küba SG *industrial* is a master of customisation. No matter how great the demand for power, the Küba SG *industrial* is the answer. Its versatility allows the Küba SG *industrial* to master the most complex refrigeration tasks.

Q_0 5 — ■ ■ 170 kW

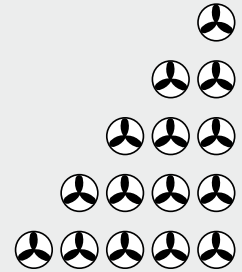

The Küba SG *industrial's* enormous air volume and directed air flow achieve maximum cooling and freezing speeds.

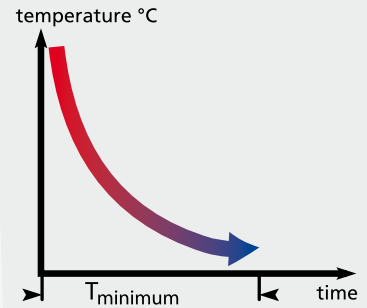

Even the standard design includes the hinge-down drip tray. This makes it easy to clean and assemble the cooler, to make service work simple.

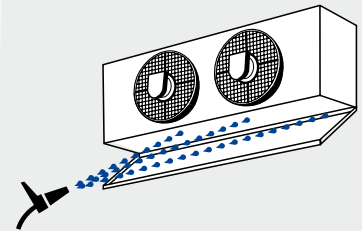

To clean the heat exchanger, hinged fans are an optional accessory. This allows easy access to the heat exchanger.

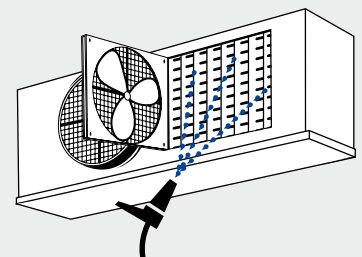



Küba SG industrial: Specific Advantages

What are the effects of a long air throw range?

Fan Guard

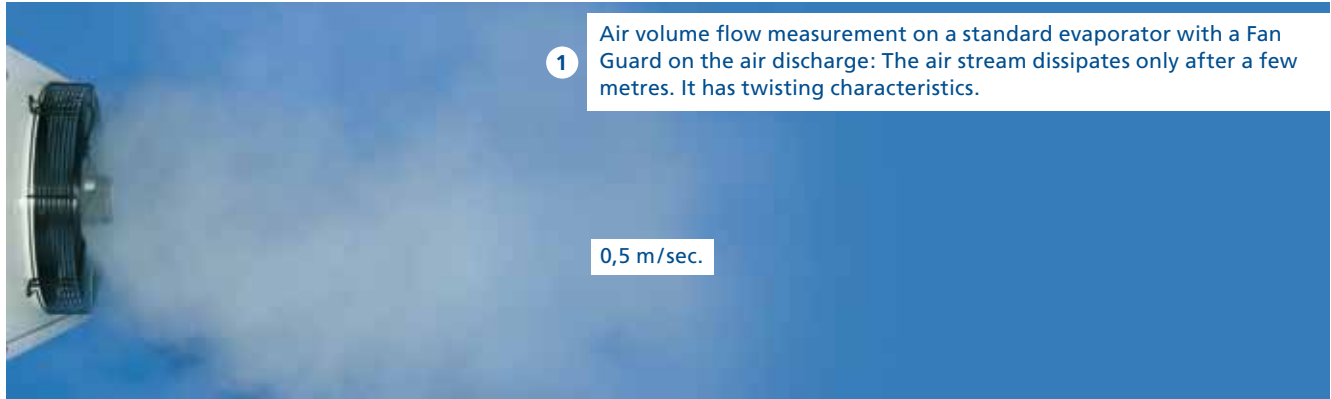

Fan Guard and Guide-Wheel

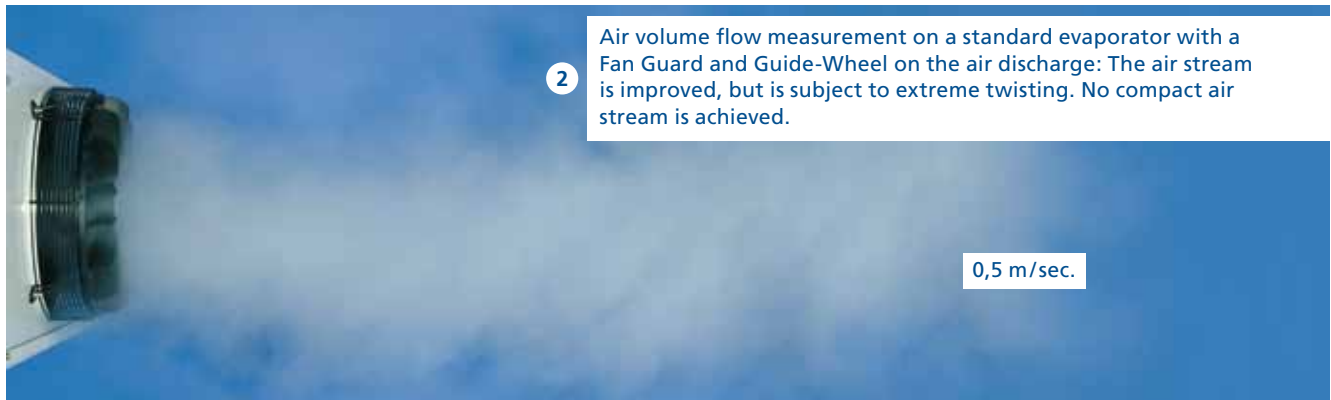

Küba Air Guiding Grid

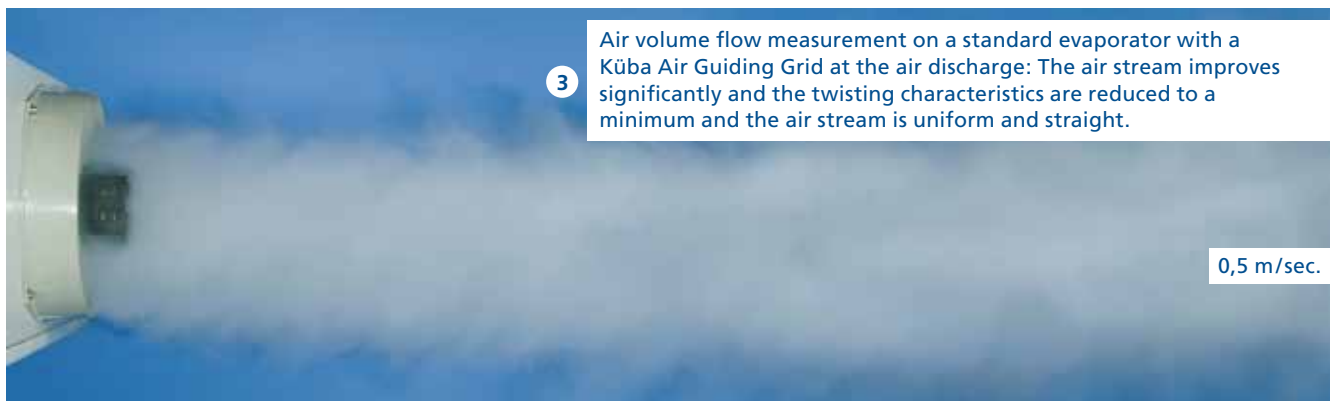

The illustration shows the Küba SG commercial line.
The illustrations also apply to the Küba SG industrial line.

Air throw comparison at a nominal capacity of 5.95 kW

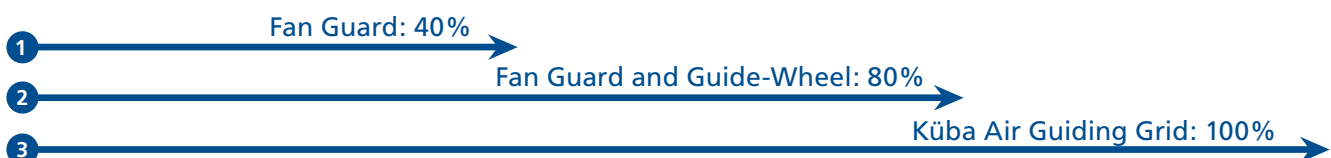



Küba SG industrial: Specific Advantages

Goods stay at a uniform temperature due to improved air distribution

Refrigeration in large, long cold storage areas can be realized with GEA Küba Air Coolers. Very long throw ranges can be achieved with the Air Guiding Grid. This allows the chilled air to reach the most remote corners of the cold storage area. When used in compliance with product specific stacking, room ventilation is trouble-free, and heat pockets are prevented.

Clear advantages are:

- Even air distribution
- Short cooling times
- Uniform product cooling
- No fluctuations in product temperatures
- Quality is retained

Küba Air Guiding Grid ➔ short cooling times

Cooling curve comparison

Küba high performance SG Air Coolers

Without Küba Air Guiding Grid

- Poor room ventilation
- Large differences in product temperatures: 6K
- Relatively long cooling times

With Küba Air Guiding Grid

- Better distribution of cooled air
- Products are cooled more evenly: 1K
- Short cooling times
- Lower temperature difference (DT1)
- Lower operational costs

Key:

- t_0 = Evaporating temperature at coil outlet
- t_{0h} = Superheated temperature at coil outlet
- t_{L1} = Air entry temperature into the Air Cooler

Küba Air Guiding Grid ➔ More uniform product temperatures

Uniform product temperatures:

As documented by the measurement series in the cold storage area

To perform the cooling curve comparison, a cold storage area was filled with stacks of goods. The measuring points 1-11 show the development of the product core temperature in relation to cooling time.

The starting conditions were identical in both trials – entry temperature 24 °C. For the cooler without an Air Guiding Grid, the temperature difference in the stack of goods after 21 hours cooling time was 6K.

The Küba SG with Air Guiding Grid achieved the outstanding result of only a 1K temperature difference.

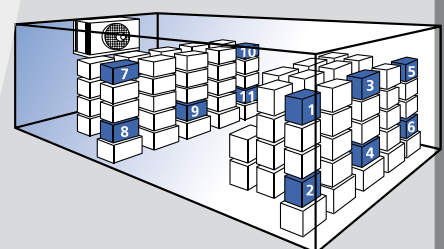
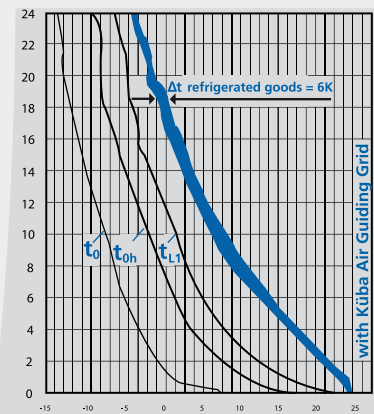
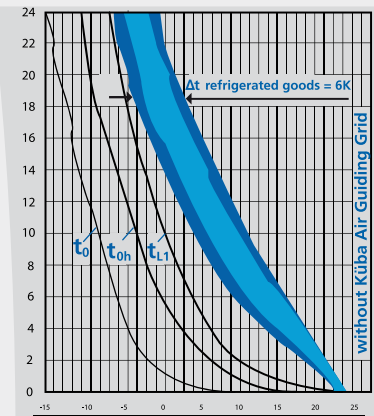
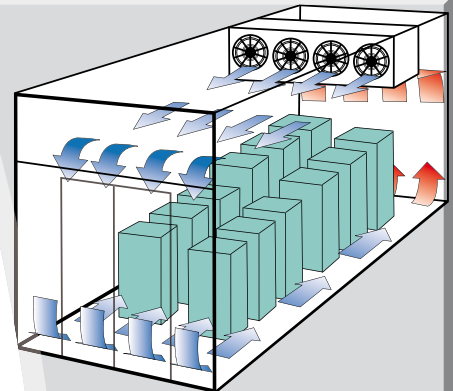



Construction

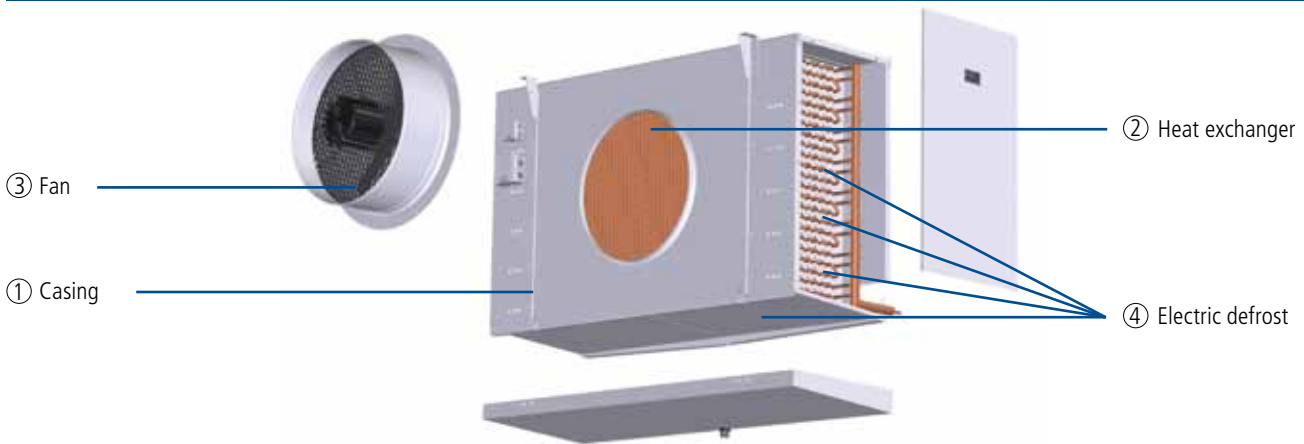

1. Casing

- Smooth Sendzimir galvanised steel
- High-grade powder coating, papyrus white RAL 9018
 - Food safe
 - Easy to clean
 - Optimum corrosion protection
- Hinge-down drip tray and removable side panels
- Stainless steel mounting material
- Plastic drain up to 1 1/4", longer than 2", stainless steel

2. Heat exchanger

- Fin spacing
 - SGA.I: 4,5 mm
 - SGB.I: 7 mm
 - SGK.I: 12 mm
- Aligned tube arrangement, spacing 50 x 50 mm
- HFE® tube / fin system
- **SG industrial-F: HFC/CO₂**
Küba-CAL® refrigerant distributor from the entire HFC/CO₂ line (up to 32 bar)
 - Tubing: Cu-special
 - Fins: Al
 - End plates: Al
- **SG industrial-G: Glycol**
Distributor tubes for multiple injections
 - Tubing: Cu-special
 - Fins: Al
 - End plates: Al
- **SG industrial-N: Pump operation, NH₃**
Distributor tubes for multiple injections
 - Tubing: VA
 - Fins: Al
 - End plates: Al

3. Fans

- Ø 500 / 560 / 630 / 710 / 800 mm
- With built-in protector to be connected on site

- Application range: -40 °C to +45 °C
- 400 ± 10% V-3~ 50Hz
- In the standard design the fans are equipped with Air Guiding Grid, air duct and contact protection.
- Protection class IP 66
- Insulation class F
- Operating data can be found with Küba Select or in the technical data.
- Optional Controller:
 - Phase control
 - Transformer
 - Delta / star
 - Frequency converter with all-pole sinusoidal filter

⚠ Please observe the manufacturer's information.

Motor label data (max. allowable value +40 °C)
50 Hz

	min ⁻¹	W	A
SG. 50-F41-F85	1400	800	1,40
SG. 56-F41-F85	1350	1400	2,50
SG. 63-F41-F85	880	680	1,60
SG. 71-F41-F84	900	1200	2,30
SG. 80-F41-F84	930	2200	3,50

4. Electric defrost

- 230 ± 10% V-1~ or 400 ± 10% V-3~ -Y
- Heaters with CrNi steel sleeve
- Vapour-tight connections
- Connector cable 1,5 mm² x 1000 mm
- Designed to defrost the heat exchanger quickly and evenly
- To prevent vapor build-up and to promote heat exchange with little loss, the heaters are mounted in special expanded tube sleeves
- Wired ready for connection to the connection box in accordance with VDE specifications



Refrigerant / Coolant

- Can be used with all HFC refrigerants. Performance data can be found with Küba Select (Product Selection Software)
- For water / brine circulation choose your Air Cooler with Küba Select
- For CO₂ operation and for NH₃ applications immediate selection with Küba Select is possible – or ask our technical staff in sales



The performance data in the Q_v Charts refer to the combination of materials: tubes, Cu / fins, Al.

Küba **Blue Line**
Aircoolers

Fresh solutions.



Technical Data (R404A)

SGA-F



Nomenclature

Standard

SG A E 71 - F 6 2

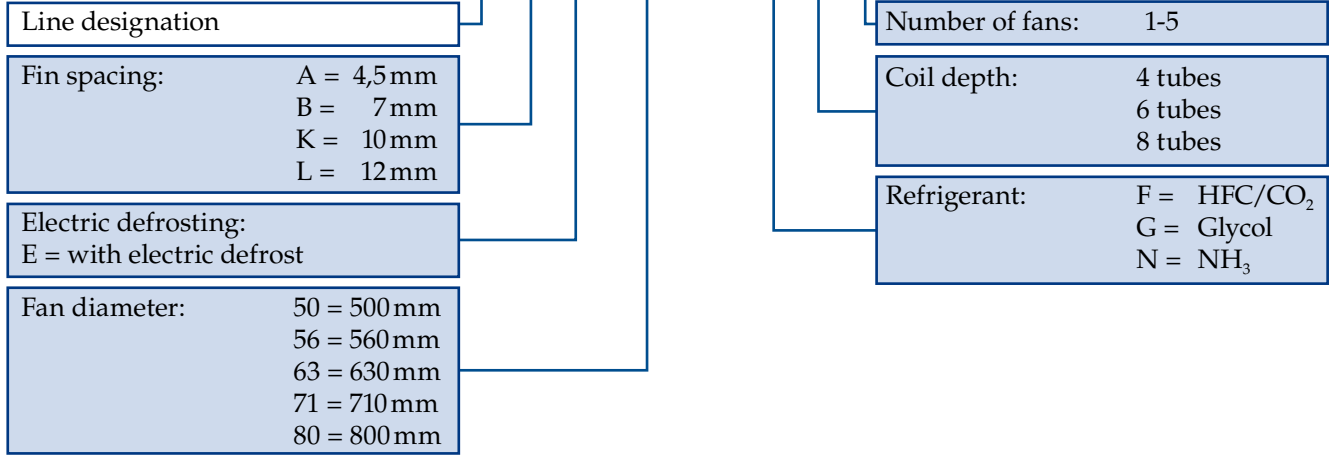

SGA(E)-F

Model	Rating Q ₀ at 50 Hz		Surface	Air flow		Air throw		Tube volume	Connections			Per Fan 400 ± 10% V-3~ 50Hz (operating values at 50 Hz)		
	t _{li} ± 0 °C DT1 = 8K	t _{li} -18 °C DT1 = 7K		m ²	m ³ /h	m	m		dm ³	Inlet Ø mm	Outlet Ø mm	Blade Ø mm	min ⁻¹	W
50-F41	⊕	9,8	7,9	55	5900	23	15	9	10	28	500	1390	657	1,32
50-F61	⊕	12,2	9,8	82	5400	23	15	13	10	28	500	1390	657	1,32
56-F41	⊕	12,5	10,1	73	7200	28	18	12	10	28	560	1338	813	1,78
56-F61	⊕	15,7	12,5	110	6750	28	18	17	15	35	560	1338	813	1,78
56-F81	⊕	17,6	14,1	146	6300	28	18	23	15	35	560	1338	813	1,78
63-F41	⊕	15,5	12,3	99	8010	33	21	16	15	28	630	919	539	1,38
63-F61	⊕	19,2	15,3	148	7650	33	21	23	22	35	630	919	539	1,38
63-F81	⊕	21,1	16,7	198	7020	33	21	31	22	35	630	919	539	1,38
71-F41	⊕	23,1	18,5	154	11700	43	26	24	15	35	710	940	1140	2,39
71-F61	⊕	28,3	22,6	231	11000	43	26	36	22	35	710	940	1140	2,39
71-F81	⊕	31,6	25,2	308	10400	43	26	48	22	42	710	940	1140	2,39
80-F41	⊕	31,8	25,5	179	18450	48	-	28	15	42	800	940	1630	3,46
80-F61	⊕	39,5	31,5	269	17460	48	-	42	22	42	800	940	1630	3,46
80-F81	⊕	44,0	35,1	359	16200	48	-	56	22	42	800	940	1630	3,46
50-F42	⊕⊕	19,6	15,6	110	11800	33	21	17	15	35	500	1390	657	1,32
50-F62	⊕⊕	24,6	19,6	164	10800	33	21	25	15	35	500	1390	657	1,32
56-F42	⊕⊕	25,1	20,1	146	14400	39	25	22	15	35	560	1338	813	1,78
56-F62	⊕⊕	31,6	25,2	220	13500	39	25	34	22	42	560	1338	813	1,78
56-F82	⊕⊕	35,3	28,2	292	12600	39	25	45	22	42	560	1338	813	1,78
63-F42	⊕⊕	30,8	24,6	198	16020	45	29	30	22	42	630	919	539	1,38
63-F62	⊕⊕	38,6	30,8	296	15300	45	29	45	22	42	630	919	539	1,38
63-F82	⊕⊕	42,1	33,6	396	14040	45	29	60	22	42	630	919	539	1,38
71-F42	⊕⊕	46,3	37,1	308	23400	58	35	46	22	42	710	940	1140	2,39
71-F62	⊕⊕	56,8	45,3	462	22000	58	35	70	28	54	710	940	1140	2,39
71-F82	⊕⊕	63,2	50,5	616	20800	58	35	93	28	54	710	940	1140	2,39
80-F42	⊕⊕	63,7	51,0	358	36900	63	-	54	22	54	800	940	1630	3,46
80-F62	⊕⊕	79,0	63,1	538	34920	63	-	82	2x22	2x42	800	940	1630	3,46
80-F82	⊕⊕	88,0	70,2	718	32400	63	-	108	2x22	2x42	800	940	1630	3,46
50-F43	⊕⊕⊕	29,5	23,5	165	17700	40	26	25	15	42	500	1390	657	1,32
50-F63	⊕⊕⊕	37,0	29,5	246	16200	40	26	37	22	42	500	1390	657	1,32
56-F43	⊕⊕⊕	37,7	30,1	220	21600	49	32	33	15	42	560	1338	813	1,78
56-F63	⊕⊕⊕	47,5	37,8	330	20250	49	32	50	22	42	560	1338	813	1,78



Technical Data (R404A)

SGA-F



SGA(E)-F

Model	Rating Q _e at 50 Hz	Surface		Air flow		Air throw		Tube volume	Connections			Per Fan 400 ± 10% V-3 ~ 50Hz (operating values at 50 Hz)		
		ε ₁ ± 0 °C DT1 = 8K	ε ₁ -18 °C DT1 = 7K	m ²	m ³ /h	m	m		Inlet	Outlet	Blade	min ⁻¹	W	A
56-F83	⊗⊗⊗	53,1	42,3	438	18900	49	32	66	22	54	560	1338	813	1,78
63-F43	⊗⊗⊗	46,3	37,1	297	24030	58	38	45	22	42	630	919	539	1,38
63-F63	⊗⊗⊗	58,0	46,2	444	22950	58	38	67	22	54	630	919	539	1,38
63-F83	⊗⊗⊗	63,1	50,5	594	21060	58	38	89	28	54	630	919	539	1,38
71-F43	⊗⊗⊗	69,5	55,5	462	35100	68	41	69	28	54	710	940	1140	2,39
71-F63	⊗⊗⊗	85,2	68,1	693	33000	68	41	104	2x22	2x42	710	940	1140	2,39
71-F83	⊗⊗⊗	95,0	75,8	924	31200	68	41	138	2x28	2x42	710	940	1140	2,39
80-F43	⊗⊗⊗	95,7	76,5	537	55350	72	-	81	28	54	800	940	1630	3,46
80-F63	⊗⊗⊗	118,5	94,6	807	52380	72	-	121	2x28	2x54	800	940	1630	3,46
80-F83	⊗⊗⊗	132,0	105,5	1077	48600	72	-	161	2x28	2x54	800	940	1630	3,46
50-F44	⊗⊗⊗⊗	39,3	31,5	220	23600	42	27	33	15	42	500	1390	657	1,32
50-F64	⊗⊗⊗⊗	49,3	39,3	328	21600	42	27	50	22	54	500	1390	657	1,32
56-F44	⊗⊗⊗⊗	50,3	40,1	293	28800	51	33	44	22	54	560	1338	813	1,78
56-F64	⊗⊗⊗⊗	63,2	50,5	440	27000	51	33	66	28	54	560	1338	813	1,78
56-F84	⊗⊗⊗⊗	70,7	56,5	584	25200	51	33	88	2x22	2x42	560	1338	813	1,78
63-F44	⊗⊗⊗⊗	61,7	49,3	396	32040	60	39	59	22	54	630	919	539	1,38
63-F64	⊗⊗⊗⊗	77,2	61,7	592	30600	60	39	89	28	54	630	919	539	1,38
63-F84	⊗⊗⊗⊗	84,2	67,2	792	28080	60	39	118	2x22	2x42	630	919	539	1,38
71-F44	⊗⊗⊗⊗	92,7	74,1	616	46800	73	44	92	28	54	710	940	1140	2,39
71-F64	⊗⊗⊗⊗	113,6	90,7	924	44000	73	44	138	2x22	2x54	710	940	1140	2,39
71-F84	⊗⊗⊗⊗	126,6	101,1	1232	41600	73	44	184	2x28	2x54	710	940	1140	2,39
80-F44	⊗⊗⊗⊗	127,6	102,0	716	73800	74	-	107	28	64	800	940	1630	3,46
80-F64	⊗⊗⊗⊗	158,1	126,2	1076	69840	74	-	161	2x28	2x54	800	940	1630	3,46
80-F84	⊗⊗⊗⊗	176,0	140,5	1436	64800	74	-	214	2x28	2x54	800	940	1630	3,46
50-F45	⊗⊗⊗⊗⊗	49,1	39,2	275	29500	47	31	41	22	54	500	1390	657	1,32
50-F65	⊗⊗⊗⊗⊗	61,6	49,2	410	27000	47	31	62	22	54	500	1390	657	1,32
56-F45	⊗⊗⊗⊗⊗	63,0	50,2	366	36000	56	36	55	22	54	560	1338	813	1,78
56-F65	⊗⊗⊗⊗⊗	79,1	63,1	550	33750	56	36	82	28	54	560	1338	813	1,78
56-F85	⊗⊗⊗⊗⊗	88,5	70,6	730	31500	56	36	109	2x22	2x42	560	1338	813	1,78
63-F45	⊗⊗⊗⊗⊗	77,2	61,7	495	40050	66	43	74	22	54	630	919	539	1,38
63-F65	⊗⊗⊗⊗⊗	96,5	77,1	740	38250	66	43	111	28	54	630	919	539	1,38
63-F85	⊗⊗⊗⊗⊗	105,3	84,1	990	35100	66	43	147	2x22	2x54	630	919	539	1,38



Q_v Chart (EN 328, R404A)

SGA-F



t_{l1} [°C] Air inlet temperature

Q₀ [kW] Cooling capacity

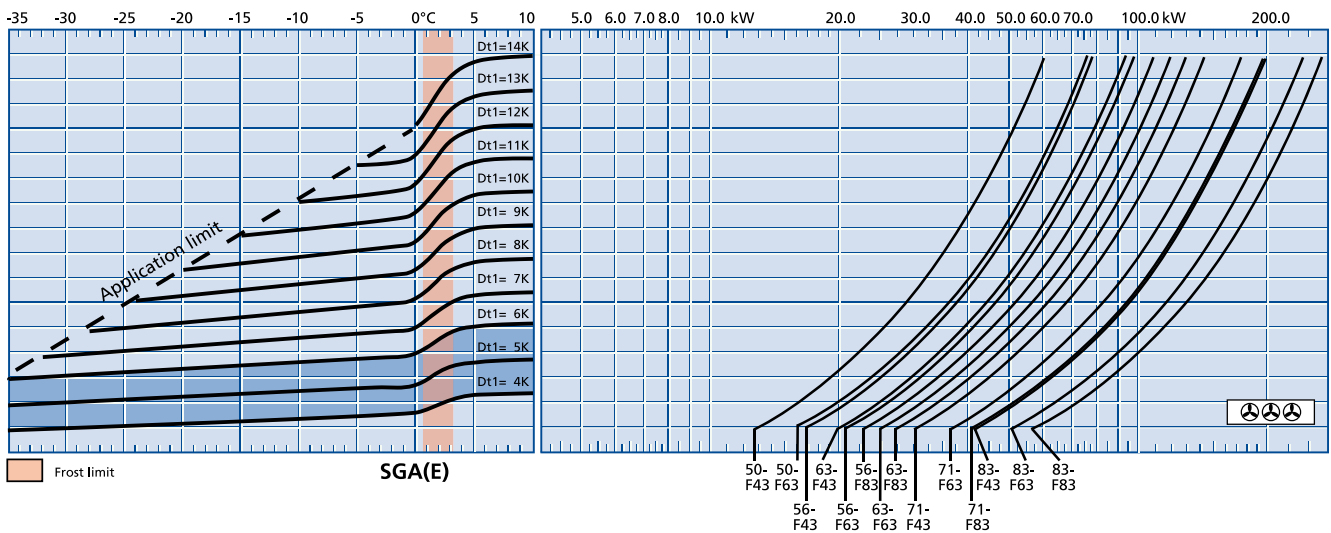
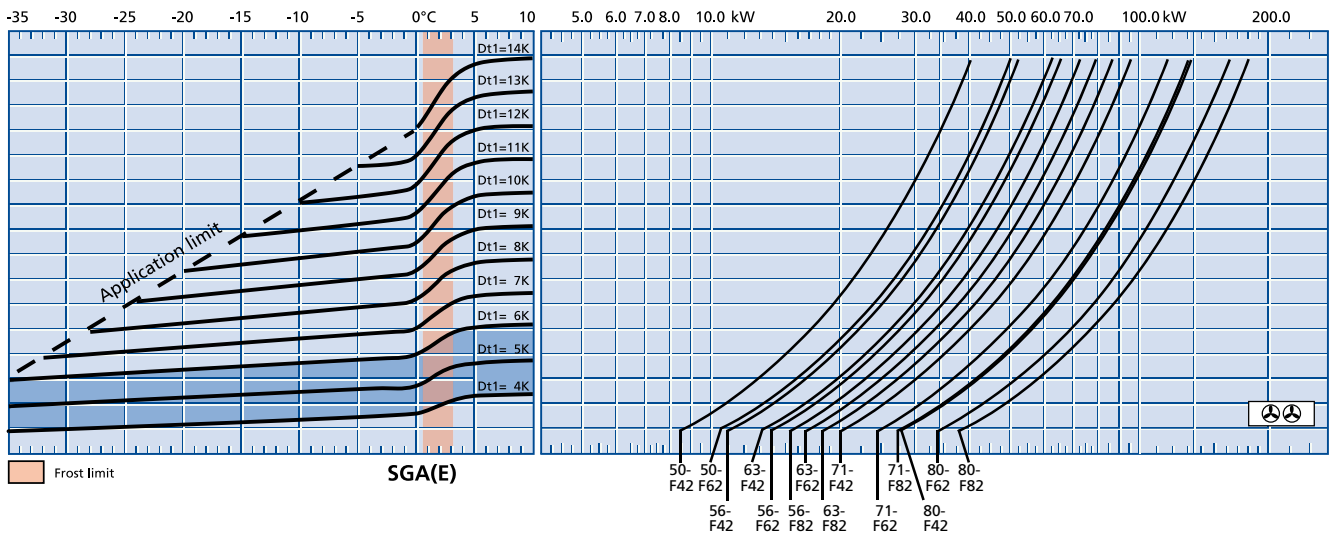
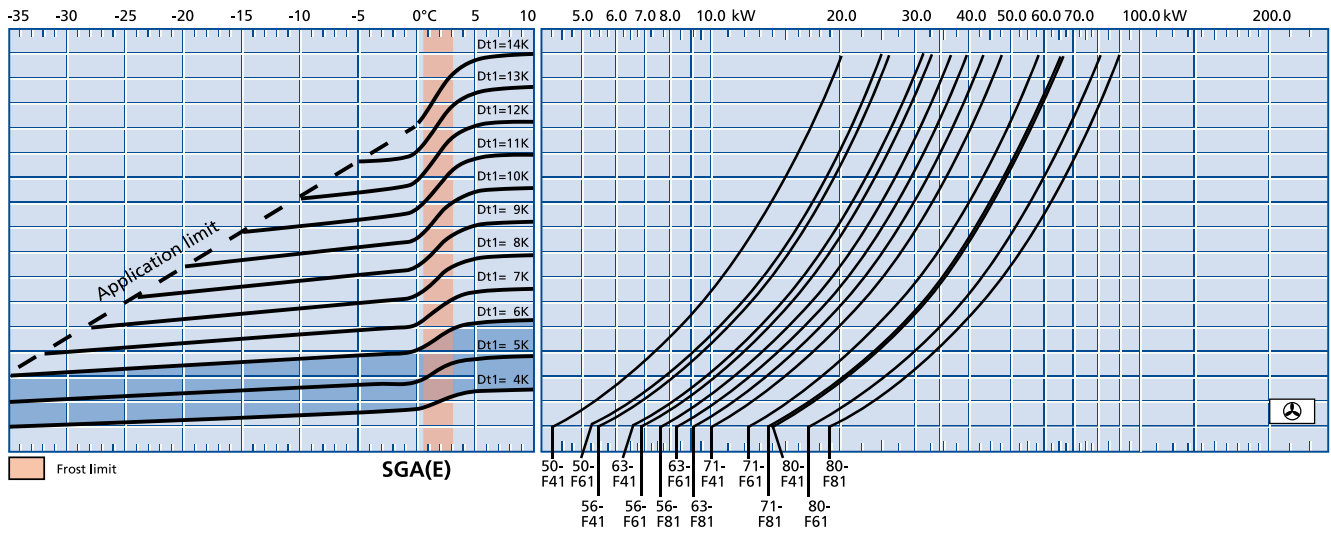

74



Q_v Chart (EN 328, R404A) SGA-F **4,5 mm**

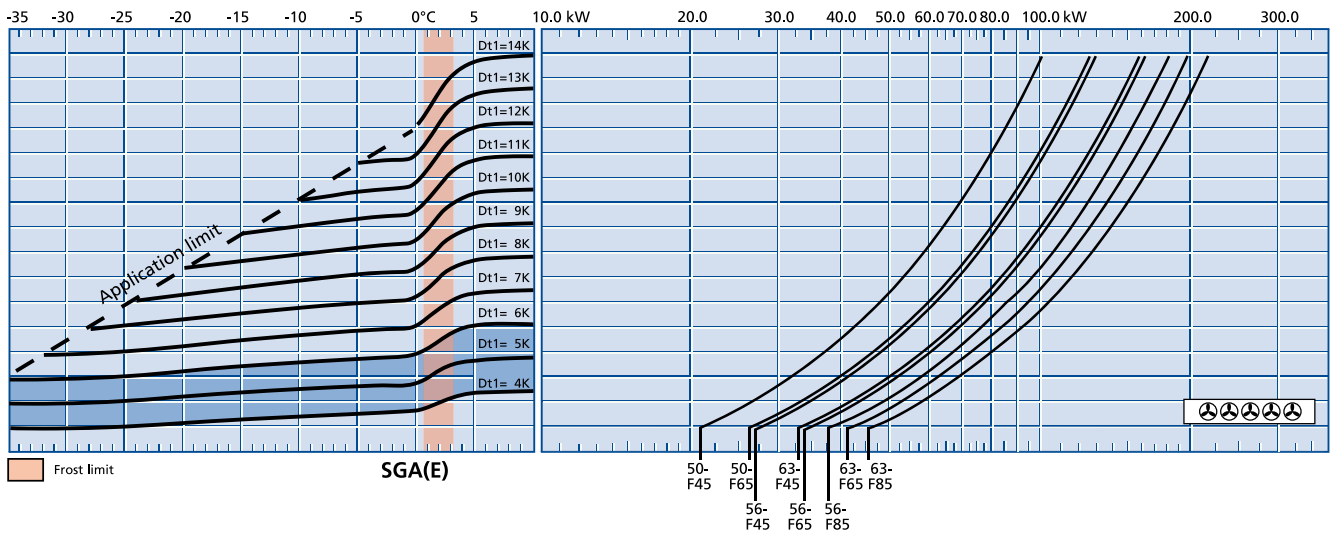
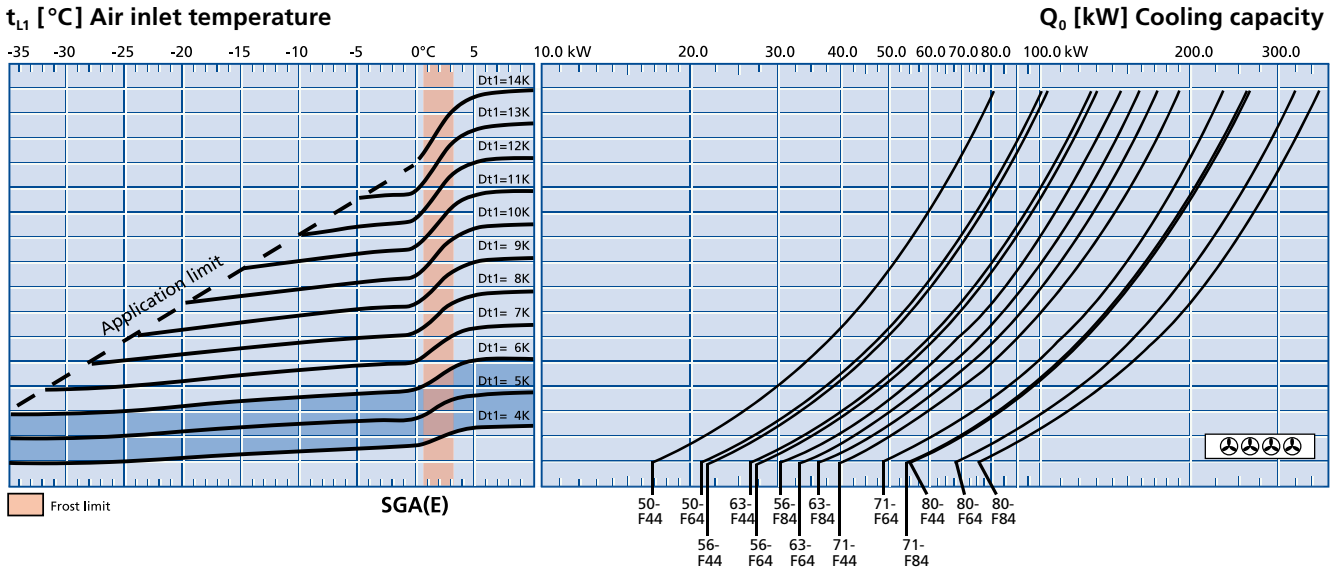

Q₀ = Cooling capacity
 t_{L1} = Air inlet temperature
 t₀ [°C] = Evaporating temperature (coil outlet)
 DT1 [K] = Temperature difference = t_{L1} - t₀ (°C)

DT1 = 4 K bis 6 K
 with electronic expansion valve

Example selection:
 For examples and explanations, please see the information section on pg. 136.



Technical Data (R404A)

SGB-F



SGB(E)-F

Model		Rating Q ₀ at 50 Hz		Surface	Air flow	Air throw		Tube volume	Connections			Per Fan 400 ± 10% V-3~ 50Hz (operating values at 50 Hz)		
		t _{li} ± 0 °C DT1 = 8K	t _{li} -18 °C DT1 = 7K			Inlet	Outlet		Blade	min ⁻¹	W	A		
SGB(E)														
		kW	kW	m ²	m ³ /h	m	m	dm ³	Ø mm	Ø mm	Ø mm			
50-F41	⊗	7,9	6,3	36	6300	25	16	9	10	28	500	1390	657	1,32
50-F61	⊗	10,6	8,5	54	5900	25	16	13	10	28	500	1390	657	1,32
56-F41	⊗	10,5	8,5	48	7900	30	20	12	10	28	560	1338	813	1,78
56-F61	⊗	14,1	11,2	72	7500	30	20	17	15	35	560	1338	813	1,78
56-F81	⊗	16,5	13,1	97	7300	30	20	23	15	35	560	1338	813	1,78
63-F41	⊗	12,6	10,1	65	8600	35	23	16	15	28	630	919	539	1,38
63-F61	⊗	16,6	13,2	98	8400	35	23	23	22	35	630	919	539	1,38
63-F81	⊗	19,7	15,7	130	8200	35	23	31	22	35	630	919	539	1,38
71-F41	⊗	19,1	15,2	101	12300	45	27	24	15	35	710	940	1140	2,39
71-F61	⊗	25,1	20,1	152	12000	45	27	36	22	35	710	940	1140	2,39
71-F81	⊗	29,2	23,3	203	11600	45	27	48	22	42	710	940	1140	2,39
80-F41	⊗	26,3	21,1	118	20250	50	-	28	15	42	800	940	1630	3,46
80-F61	⊗	31,6	25,2	177	19350	50	-	42	22	42	800	940	1630	3,46
80-F81	⊗	38,6	30,8	236	18450	50	-	56	22	42	800	940	1630	3,46
50-F42	⊗⊗	15,8	12,6	72	12600	36	23	17	15	35	500	1390	657	1,32
50-F62	⊗⊗	21,3	17,1	109	11800	36	23	25	15	35	500	1390	657	1,32
56-F42	⊗⊗	21,1	16,8	96	15800	42	27	22	15	35	560	1338	813	1,78
56-F62	⊗⊗	28,1	22,5	145	15000	42	27	34	22	42	560	1338	813	1,78
56-F82	⊗⊗	32,8	26,2	193	14600	42	27	45	22	42	560	1338	813	1,78
63-F42	⊗⊗	25,3	20,2	130	17200	48	31	30	22	42	630	919	539	1,38
63-F62	⊗⊗	33,3	26,6	195	16800	48	31	45	22	42	630	919	539	1,38
63-F82	⊗⊗	39,5	31,6	260	16400	48	31	60	22	42	630	919	539	1,38
71-F42	⊗⊗	38,3	30,6	202	24600	61	37	46	22	42	710	940	1140	2,39
71-F62	⊗⊗	50,3	40,1	304	24000	61	37	70	28	54	710	940	1140	2,39
71-F82	⊗⊗	58,5	46,7	406	23200	61	37	93	28	54	710	940	1140	2,39
80-F42	⊗⊗	52,8	42,1	236	40500	66	-	54	22	54	800	940	1630	3,46
80-F62	⊗⊗	63,2	50,5	354	38700	66	-	82	2x22	2x42	800	940	1630	3,46
80-F82	⊗⊗	77,2	61,7	472	36900	66	-	108	2x22	2x42	800	940	1630	3,46
50-F43	⊗⊗⊗	23,7	19,0	109	18900	44	29	25	15	42	500	1390	657	1,32
50-F63	⊗⊗⊗	32,1	25,6	163	17700	44	29	37	22	42	500	1390	657	1,32
56-F43	⊗⊗⊗	31,7	25,3	145	23700	53	34	33	15	42	560	1338	813	1,78
56-F63	⊗⊗⊗	42,2	33,7	217	22500	53	34	50	22	42	560	1338	813	1,78

76



Technical Data (R404A) SGB-F 

SGB(E)-F

Model	Rating Q ₀ at 50 Hz		Surface m ²	Air flow m ³ /h	Air throw m		Tube volume dm ³	Connections			Per Fan 400 ± 10% V-3 ~ 50Hz (operating values at 50 Hz)			
	t ₁ ± 0 °C DT1 = 8K	t ₁ -18 °C DT1 = 7K			Inlet Ø mm	Outlet Ø mm		Blade Ø mm	min ⁻¹	W	A			
SGB(E)	kW	kW												
56-F83	⊗⊗⊗	49,3	39,3	290	21900	53	34	66	22	54	560	1338	813	1,78
63-F43	⊗⊗⊗	38,1	30,5	195	25800	62	40	45	22	42	630	919	539	1,38
63-F63	⊗⊗⊗	50,1	40,0	293	25200	62	40	67	22	54	630	919	539	1,38
63-F83	⊗⊗⊗	59,5	47,5	390	24600	62	40	89	28	54	630	919	539	1,38
71-F43	⊗⊗⊗	57,5	46,0	303	36900	72	43	69	28	54	710	940	1140	2,39
71-F63	⊗⊗⊗	75,5	60,3	456	36000	72	43	104	2x22	2x42	710	940	1140	2,39
71-F83	⊗⊗⊗	87,8	70,1	609	34800	72	43	138	2x28	2x42	710	940	1140	2,39
80-F43	⊗⊗⊗	79,2	63,2	354	60750	76	-	81	28	54	800	940	1630	3,46
80-F63	⊗⊗⊗	95,0	75,8	531	58050	76	-	121	2x28	2x54	800	940	1630	3,46
80-F83	⊗⊗⊗	116,0	92,5	708	55350	76	-	161	2x28	2x54	800	940	1630	3,46
50-F44	⊗⊗⊗⊗	31,6	25,2	145	25200	46	30	33	15	42	500	1390	657	1,32
50-F64	⊗⊗⊗⊗	42,8	34,2	217	23600	46	30	50	22	54	500	1390	657	1,32
56-F44	⊗⊗⊗⊗	42,3	33,8	193	31600	55	36	44	22	54	560	1338	813	1,78
56-F64	⊗⊗⊗⊗	56,3	45,0	289	30000	55	36	66	28	54	560	1338	813	1,78
56-F84	⊗⊗⊗⊗	65,7	52,5	386	29200	55	36	88	2x22	2x42	560	1338	813	1,78
63-F44	⊗⊗⊗⊗	50,8	40,5	260	34400	64	42	59	22	54	630	919	539	1,38
63-F64	⊗⊗⊗⊗	66,7	53,3	391	33600	64	42	89	28	54	630	919	539	1,38
63-F84	⊗⊗⊗⊗	79,2	63,2	520	32800	64	42	118	2x22	2x42	630	919	539	1,38
71-F44	⊗⊗⊗⊗	76,7	61,3	404	49200	77	46	92	28	54	710	940	1140	2,39
71-F64	⊗⊗⊗⊗	100,6	80,5	608	48000	77	46	138	2x28	2x54	710	940	1140	2,39
71-F84	⊗⊗⊗⊗	117,1	93,5	812	46400	77	46	184	2x28	2x54	710	940	1140	2,39
80-F44	⊗⊗⊗⊗	105,6	84,5	472	81000	78	-	107	28	64	800	940	1630	3,46
80-F64	⊗⊗⊗⊗	126,6	101,1	708	77400	78	-	161	2x28	2x54	800	940	1630	3,46
80-F84	⊗⊗⊗⊗	154,5	123,5	944	73800	78	-	214	2x28	2x54	800	940	1630	3,46
50-F45	⊗⊗⊗⊗⊗	39,5	31,6	181	31500	51	33	41	22	54	500	1390	657	1,32
50-F65	⊗⊗⊗⊗⊗	53,5	42,7	272	29500	51	33	62	22	54	500	1390	657	1,32
56-F45	⊗⊗⊗⊗⊗	53,0	42,2	241	39500	60	39	55	22	54	560	1338	813	1,78
56-F65	⊗⊗⊗⊗⊗	70,3	56,2	362	37500	60	39	82	28	54	560	1338	813	1,78
56-F85	⊗⊗⊗⊗⊗	82,2	65,6	483	36500	60	39	109	2x22	2x42	560	1338	813	1,78
63-F45	⊗⊗⊗⊗⊗	63,5	50,7	326	43000	70	46	74	22	54	630	919	539	1,38
63-F65	⊗⊗⊗⊗⊗	83,5	66,6	489	42000	70	46	111	28	54	630	919	539	1,38
63-F85	⊗⊗⊗⊗⊗	99,1	79,1	650	41000	70	46	147	2x22	2x54	630	919	539	1,38



Q_v Chart (EN 328, R404A)

SGB-F



t_{l1} [°C] Air inlet temperature

Q_o [kW] Cooling capacity

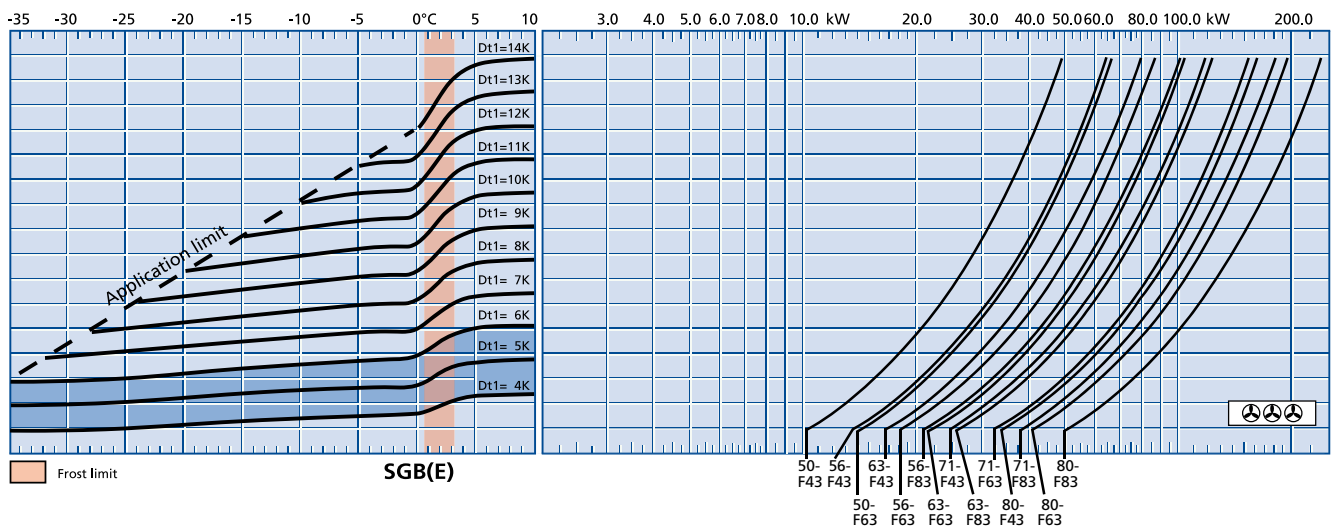
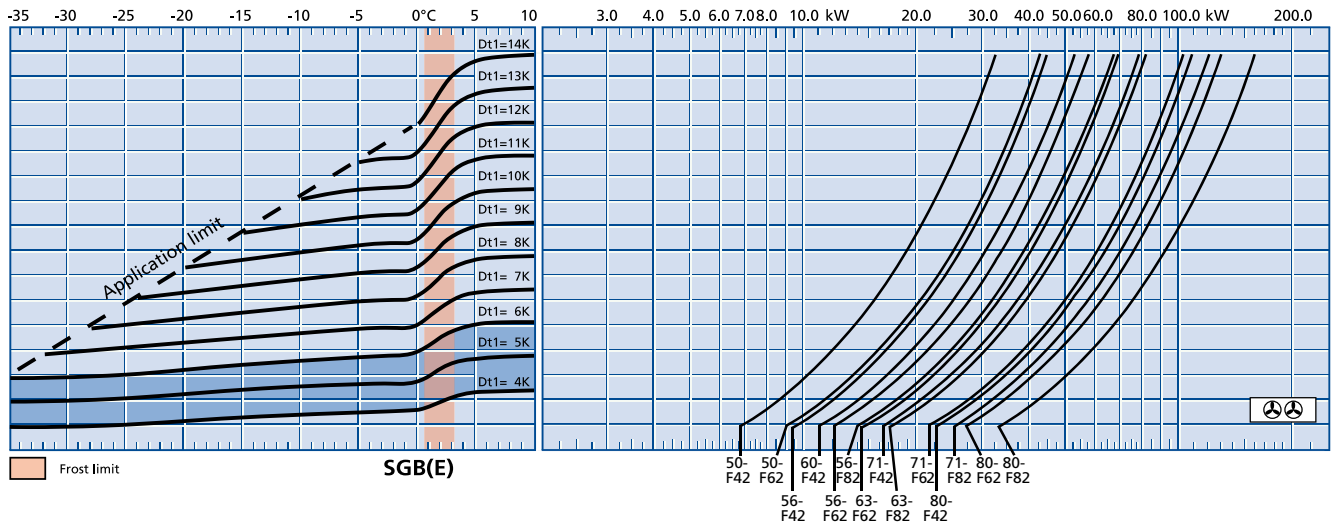
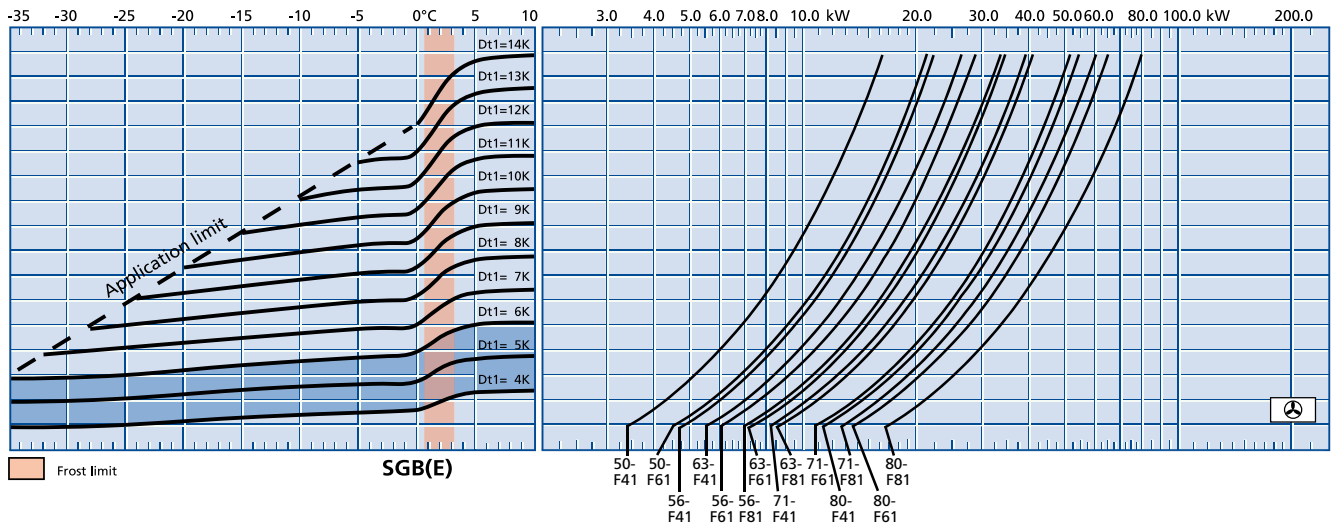

78



Q_v Chart (EN 328, R404A) SGB-F  **7 mm**

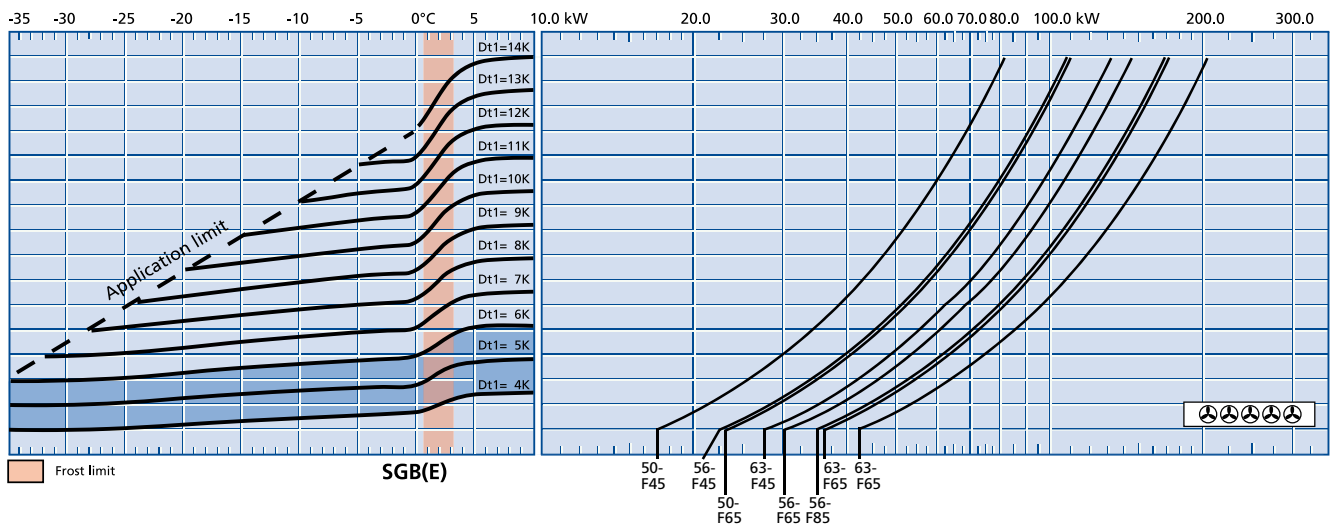
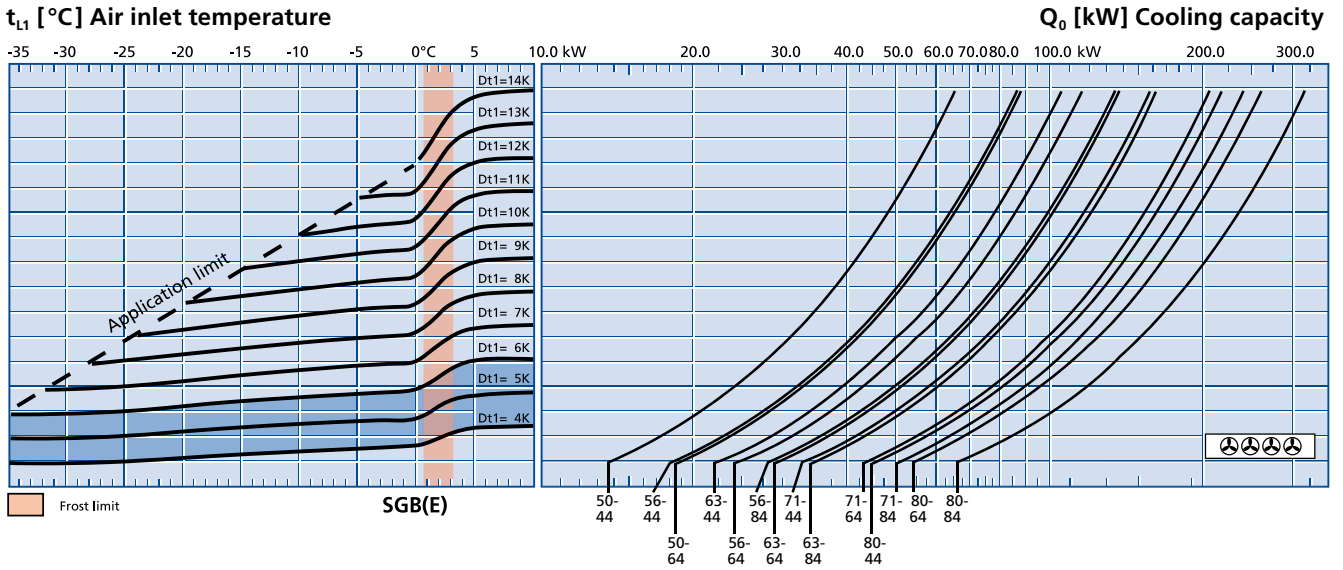

Q₀ = Cooling capacity
 t_{L1} = Air inlet temperature
 t₀ [°C] = Evaporating temperature (coil outlet)
 DT1 [K] = Temperature difference = t_{L1} - t₀ (°C)

**DT1 = 4 K bis 6 K
 with electronic expansion valve**

Example selection:
 For examples and explanations, please see the information section on pg. 136.



Technical Data (R404A)

SGK-F



SGK(E)-F

Model		Rating Q ₀ at 50 Hz		Surface	Air flow		Air throw		Tube volume	Connections			Per Fan 400 ± 10% V-3~ 50Hz (operating values at 50 Hz)		
		t _{li} ± 0 °C DT1 = 8K	t _{li} -18 °C DT1 = 7K		m ²	m ³ /h	m	m		dm ³	Inlet Ø mm	Outlet Ø mm	Blade Ø mm	min ⁻¹	W
SGK(E)		kW	kW	m ²	m ³ /h	m	m	dm ³	Ø mm	Ø mm	Ø mm	min ⁻¹	W	A	
50-F41	⊕	6,6	5,3	26	6500	26	17	9	10	28	500	1390	657	1,32	
50-F61	⊕	9,3	7,5	39	6300	26	17	13	10	28	500	1390	657	1,32	
56-F41	⊕	8,6	7,0	35	8000	31	20	12	10	28	560	1338	813	1,78	
56-F61	⊕	11,7	9,5	52	7600	31	20	17	15	35	560	1338	813	1,78	
56-F81	⊕	14,1	11,3	69	7400	31	20	23	15	35	560	1338	813	1,78	
63-F41	⊕	11,0	8,7	47	9100	36	23	16	15	28	630	919	539	1,38	
63-F61	⊕	14,5	11,5	70	8800	36	23	23	22	35	630	919	539	1,38	
63-F81	⊕	17,2	13,7	94	8500	36	23	31	22	35	630	919	539	1,38	
71-F41	⊕	15,6	12,5	73	12800	46	28	24	15	35	710	940	1140	2,39	
71-F61	⊕	21,6	17,2	109	12400	46	28	36	22	35	710	940	1140	2,39	
71-F81	⊕	26,1	20,7	146	12150	46	28	48	22	42	710	940	1140	2,39	
80-F41	⊕	22,3	17,8	85	21150	51	-	28	15	42	800	940	1630	3,46	
80-F61	⊕	27,8	22,2	128	20520	51	-	42	22	42	800	940	1630	3,46	
80-F81	⊕	34,6	27,6	170	19800	51	-	56	22	42	800	940	1630	3,46	
50-F42	⊕⊕	13,1	10,5	52	13000	37	24	17	15	35	500	1390	657	1,32	
50-F62	⊕⊕	18,6	14,8	78	12600	37	24	25	15	35	500	1390	657	1,32	
56-F42	⊕⊕	17,5	13,8	69	16000	43	28	22	15	35	560	1338	813	1,78	
56-F62	⊕⊕	23,6	18,8	104	15200	43	28	34	22	42	560	1338	813	1,78	
56-F82	⊕⊕	28,3	22,6	139	14800	43	28	45	22	42	560	1338	813	1,78	
63-F42	⊕⊕	21,8	17,5	94	18200	49	32	30	22	42	630	919	539	1,38	
63-F62	⊕⊕	28,8	23,1	141	17600	49	32	45	22	42	630	919	539	1,38	
63-F82	⊕⊕	34,6	27,6	187	17000	49	32	60	22	42	630	919	539	1,38	
71-F42	⊕⊕	31,3	25,1	146	25600	62	37	46	22	42	710	940	1140	2,39	
71-F62	⊕⊕	43,3	34,6	218	24800	62	37	70	28	54	710	940	1140	2,39	
71-F82	⊕⊕	52,1	41,5	292	24300	62	37	93	28	54	710	940	1140	2,39	
80-F42	⊕⊕	44,8	35,8	170	42300	67	-	54	22	54	800	940	1630	3,46	
80-F62	⊕⊕	55,8	44,5	256	41040	67	-	82	2x22	2x42	800	940	1630	3,46	
80-F82	⊕⊕	69,2	55,3	340	39600	67	-	108	2x22	2x42	800	940	1630	3,46	
50-F43	⊕⊕⊕	19,7	15,7	78	19500	45	29	25	15	42	500	1390	657	1,32	
50-F63	⊕⊕⊕	28,1	22,3	117	18900	45	29	37	22	42	500	1390	657	1,32	
56-F43	⊕⊕⊕	26,1	20,8	104	24000	54	35	33	15	42	560	1338	813	1,78	
56-F63	⊕⊕⊕	35,5	28,3	156	22800	54	35	50	22	42	560	1338	813	1,78	



Technical Data (R404A) SGK-F 10 mm

SGK(E)-F

Model	Rating Q ₀ at 50 Hz		Surface m ²	Air flow m ³ /h		Air throw m		Tube volume dm ³	Connections			Per Fan 400 ± 10% V-3~ 50Hz (operating values at 50 Hz)		
	t ₁₁ ± 0 °C DT1 = 8K	t ₁₁ -18 °C DT1 = 7K		kW	kW	Ø mm	Ø mm		Ø mm	min ⁻¹	W	A		
SGK(E)														
56-F83	⊗⊗⊗	42,5	34,1	208	22200	54	35	66	22	54	560	1338	813	1,78
63-F43	⊗⊗⊗	32,8	26,2	141	27300	63	41	45	22	42	630	919	539	1,38
63-F63	⊗⊗⊗	43,3	34,6	211	26400	63	41	67	22	54	630	919	539	1,38
63-F83	⊗⊗⊗	52,0	41,5	281	25500	63	41	89	28	54	630	919	539	1,38
71-F43	⊗⊗⊗	47,1	37,6	219	38400	73	44	69	28	54	710	940	1140	2,39
71-F63	⊗⊗⊗	65,1	52,0	327	37200	73	44	104	2x22	2x42	710	940	1140	2,39
71-F83	⊗⊗⊗	78,1	62,5	438	36450	73	44	138	2x28	2x42	710	940	1140	2,39
80-F43	⊗⊗⊗	67,2	53,7	255	63450	77	-	81	28	54	800	940	1630	3,46
80-F63	⊗⊗⊗	83,7	66,8	384	61560	77	-	121	2x28	2x54	800	940	1630	3,46
80-F83	⊗⊗⊗	104,0	83,1	510	59400	77	-	161	2x28	2x54	800	940	1630	3,46
50-F44	⊗⊗⊗⊗	26,3	21,1	104	26000	47	31	33	15	42	500	1390	657	1,32
50-F64	⊗⊗⊗⊗	37,3	29,8	156	25200	47	31	50	22	54	500	1390	657	1,32
56-F44	⊗⊗⊗⊗	34,8	27,8	139	32000	56	36	44	22	54	560	1338	813	1,78
56-F64	⊗⊗⊗⊗	47,3	37,7	208	30400	56	36	66	28	54	560	1338	813	1,78
56-F84	⊗⊗⊗⊗	56,8	45,3	278	29600	56	36	88	2x22	2x42	560	1338	813	1,78
63-F44	⊗⊗⊗⊗	43,8	35,1	188	36400	65	42	59	22	54	630	919	539	1,38
63-F64	⊗⊗⊗⊗	57,8	46,1	281	35200	65	42	89	28	54	630	919	539	1,38
63-F84	⊗⊗⊗⊗	69,2	55,3	375	34000	65	42	118	2x22	2x42	630	919	539	1,38
71-F44	⊗⊗⊗⊗	62,7	50,1	292	51200	78	47	92	28	54	710	940	1140	2,39
71-F64	⊗⊗⊗⊗	86,7	69,2	436	49600	78	47	138	2x22	2x54	710	940	1140	2,39
71-F84	⊗⊗⊗⊗	104,1	83,2	584	48600	78	47	184	2x28	2x54	710	940	1140	2,39
80-F44	⊗⊗⊗⊗	89,7	71,6	340	84600	79	-	107	28	64	800	940	1630	3,46
80-F64	⊗⊗⊗⊗	111,6	89,1	512	82080	79	-	161	2x28	2x54	800	940	1630	3,46
80-F84	⊗⊗⊗⊗	138,5	110,7	680	79200	79	-	214	2x28	2x54	800	940	1630	3,46
50-F45	⊗⊗⊗⊗⊗	33,0	26,3	130	32500	52	34	41	22	54	500	1390	657	1,32
50-F65	⊗⊗⊗⊗⊗	46,7	37,3	196	31500	52	34	62	22	54	500	1390	657	1,32
56-F45	⊗⊗⊗⊗⊗	43,5	34,8	174	40000	61	40	55	22	54	560	1338	813	1,78
56-F65	⊗⊗⊗⊗⊗	59,1	47,2	261	38000	61	40	82	28	54	560	1338	813	1,78
56-F85	⊗⊗⊗⊗⊗	71,1	56,7	347	37000	61	40	109	2x22	2x42	560	1338	813	1,78
63-F45	⊗⊗⊗⊗⊗	54,8	43,7	235	45500	71	46	74	22	54	630	919	539	1,38
63-F65	⊗⊗⊗⊗⊗	72,2	57,7	352	44000	71	46	111	28	54	630	919	539	1,38
63-F85	⊗⊗⊗⊗⊗	86,6	69,1	469	42500	71	46	147	2x22	2x54	630	919	539	1,38



Q_v Chart (EN 328, R404A)

SGK-F



t_{l1} [°C] Air inlet temperature

Q₀ [kW] Cooling capacity

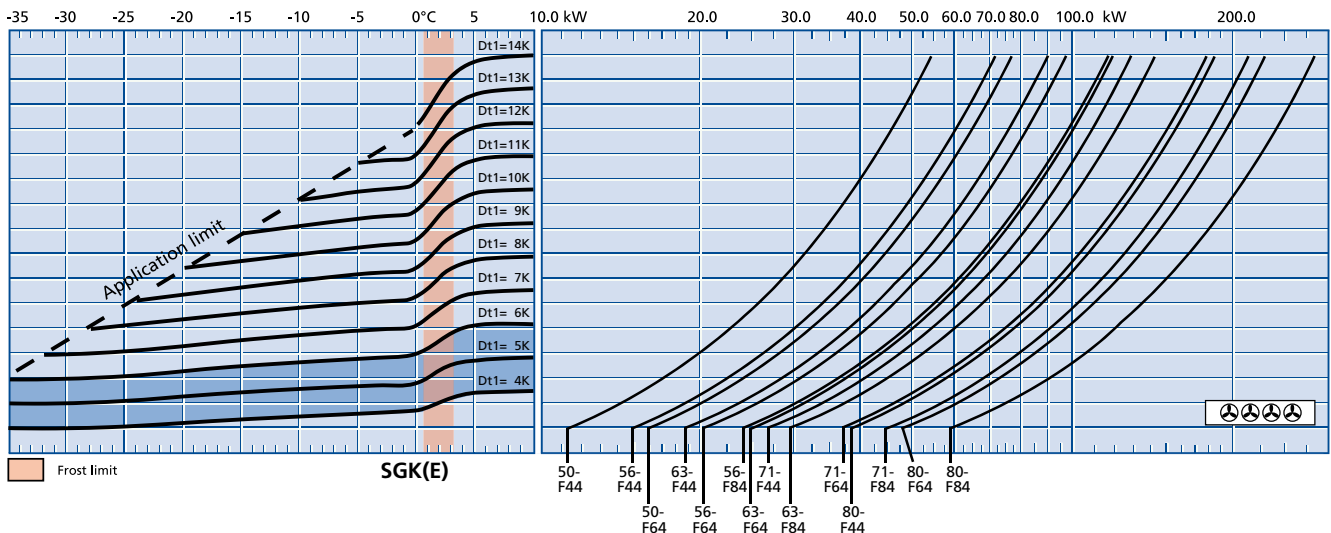
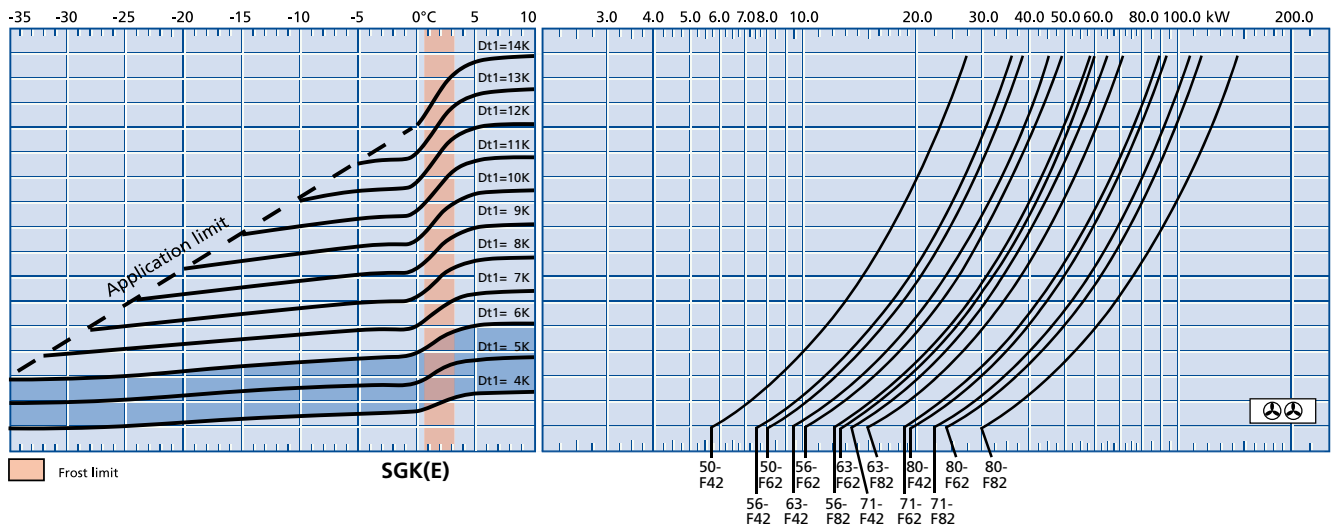
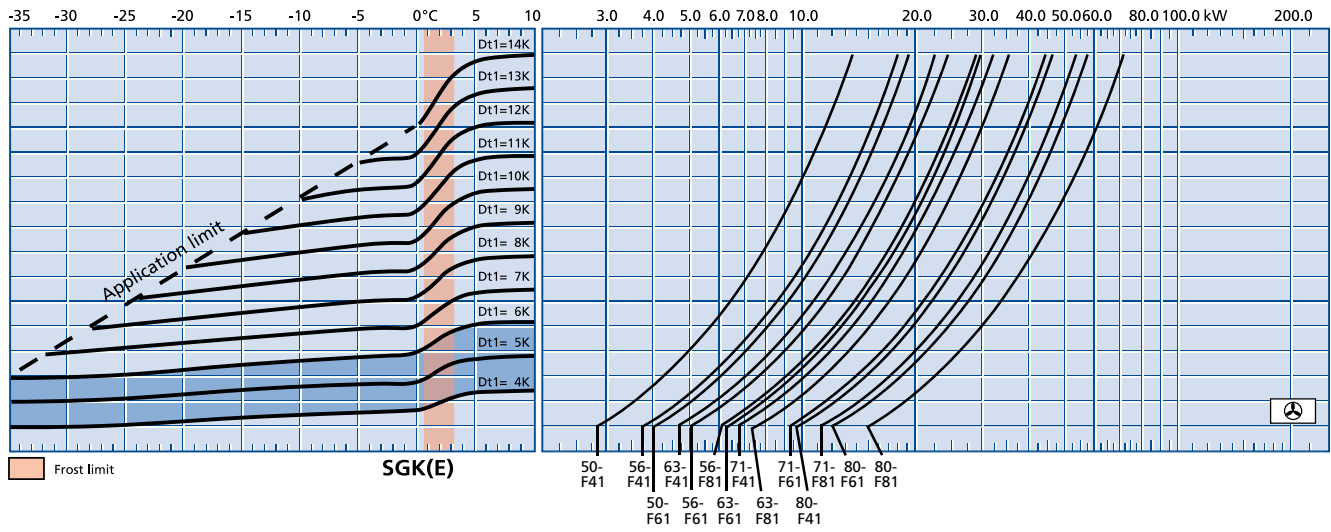

82



Q_v Chart (EN 328, R404A) SGK-F 10 mm

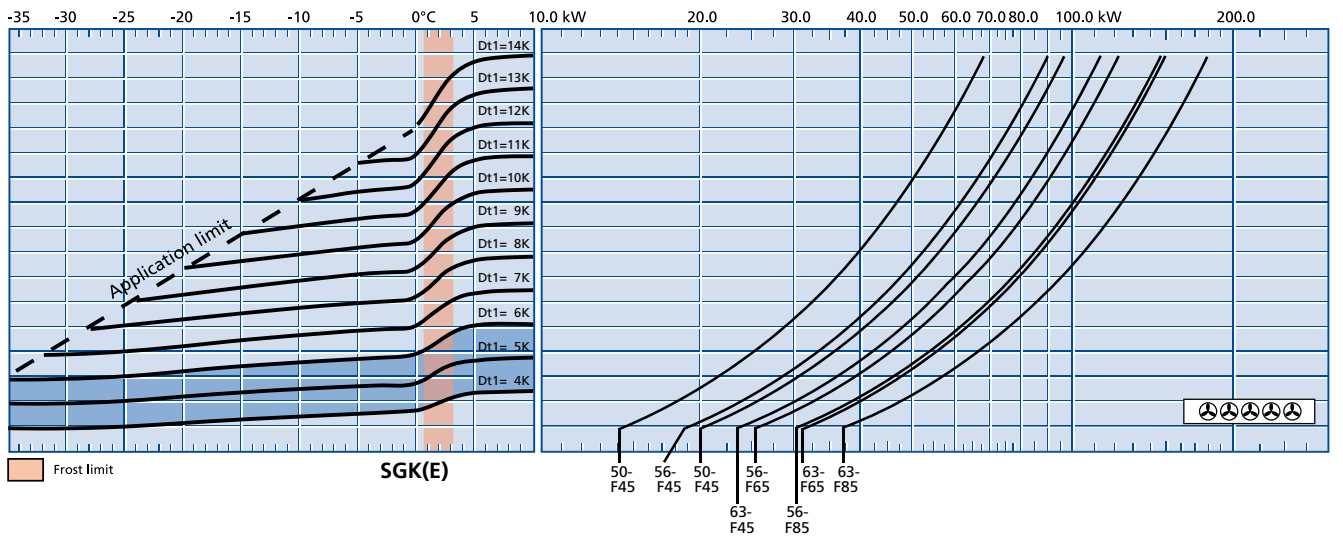
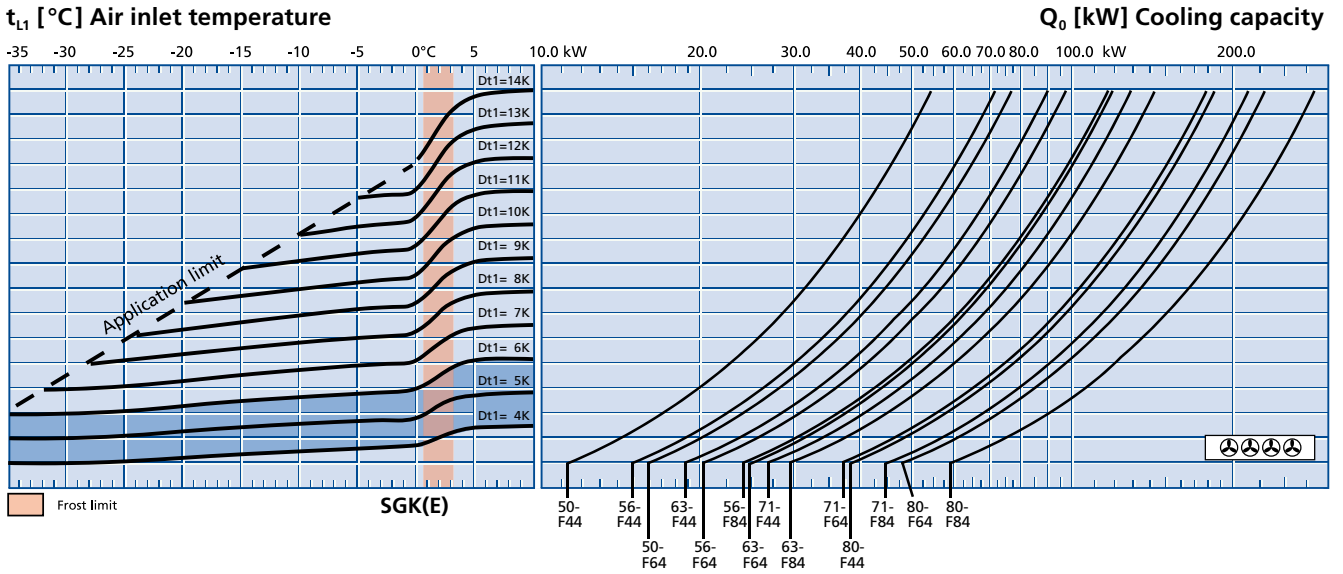

Q₀ = Cooling capacity
 t_{L1} = Air inlet temperature
 t₀ [°C] = Evaporating temperature (coil outlet)
 DT1 [K] = Temperature difference = t_{L1} - t₀ (°C)

DT1 = 4 K bis 6 K
 with electronic expansion valve

Example selection:
 For examples and explanations, please see the information section on pg. 136.



Technical Data (R404A)

SGL-F



SGL(E)-F

Model		Rating Q ₀ at 50 Hz		Surface	Air flow	Air throw		Tube volume	Connections			Per Fan 400 ± 10% V-3~ 50Hz (operating values at 50 Hz)		
		t _{li} ± 0 °C DT1 = 8K	t _{li} -18 °C DT1 = 7K			Inlet	Outlet		Blade	min ⁻¹	W	A		
SGL(E)														
		kW	kW	m ²	m ³ /h	m	m	dm ³	Ø mm	Ø mm	Ø mm			
50-F41	⊕	6,2	4,9	22	6700	27	18	9	10	28	500	1390	657	1,32
50-F61	⊕	8,5	6,8	33	6500	27	18	13	10	28	500	1390	657	1,32
56-F41	⊕	7,9	6,3	30	8100	32	21	12	10	28	560	1338	813	1,78
56-F61	⊕	11,0	8,8	44	7900	32	21	17	15	35	560	1338	813	1,78
56-F81	⊕	13,3	10,7	59	7700	32	21	23	15	35	560	1338	813	1,78
63-F41	⊕	9,7	7,8	40	9200	37	24	16	15	28	630	919	539	1,38
63-F61	⊕	13,5	10,8	60	9000	37	24	23	22	35	630	919	539	1,38
63-F81	⊕	16,0	12,7	80	8700	37	24	31	22	35	630	919	539	1,38
71-F41	⊕	14,2	11,4	62	12800	47	28	24	15	35	710	940	1140	2,39
71-F61	⊕	19,9	15,9	93	12600	47	28	36	22	35	710	940	1140	2,39
71-F81	⊕	24,2	19,3	124	12400	47	28	48	22	42	710	940	1140	2,39
80-F41	⊕	20,2	16,1	72	21600	52	-	28	15	42	800	940	1630	3,46
80-F61	⊕	24,8	19,8	108	20880	52	-	42	22	42	800	940	1630	3,46
80-F81	⊕	31,9	25,5	144	20520	52	-	56	22	42	800	940	1630	3,46
50-F42	⊕⊕	12,4	9,9	44	13400	37	24	17	15	35	500	1390	657	1,32
50-F62	⊕⊕	17,0	13,5	66	13000	37	24	25	15	35	500	1390	657	1,32
56-F42	⊕⊕	15,7	12,6	59	16200	43	28	22	15	35	560	1338	813	1,78
56-F62	⊕⊕	21,9	17,5	88	15800	43	28	34	22	42	560	1338	813	1,78
56-F82	⊕⊕	26,7	21,3	118	15400	43	28	45	22	42	560	1338	813	1,78
63-F42	⊕⊕	19,5	15,5	80	18400	49	32	30	22	42	630	919	539	1,38
63-F62	⊕⊕	26,9	21,5	119	18000	49	32	45	22	42	630	919	539	1,38
63-F82	⊕⊕	31,9	25,5	159	17400	49	32	60	22	42	630	919	539	1,38
71-F42	⊕⊕	28,4	22,7	124	25600	62	37	46	22	42	710	940	1140	2,39
71-F62	⊕⊕	39,9	31,9	186	25200	62	37	70	28	54	710	940	1140	2,39
71-F82	⊕⊕	48,4	38,6	248	24800	62	37	93	28	54	710	940	1140	2,39
80-F42	⊕⊕	40,4	32,3	144	43200	67	-	54	22	54	800	940	1630	3,46
80-F62	⊕⊕	49,6	39,6	216	41760	67	-	82	2x22	2x42	800	940	1630	3,46
80-F82	⊕⊕	63,8	51,0	288	41040	67	-	108	2x22	2x42	800	940	1630	3,46
50-F43	⊕⊕⊕	18,6	14,8	66	20100	45	29	25	15	42	500	1390	657	1,32
50-F63	⊕⊕⊕	25,4	20,3	99	19500	45	29	37	22	42	500	1390	657	1,32
56-F43	⊕⊕⊕	23,6	18,8	89	24300	54	35	33	15	42	560	1338	813	1,78
56-F63	⊕⊕⊕	32,9	26,3	133	23700	54	35	50	22	42	560	1338	813	1,78

84



Technical Data (R404A) SGL-F **12 mm**

SGL(E)-F

Model	Rating Q ₀ at 50 Hz		Surface	Air flow	Air throw		Tube volume	Connections			Per Fan 400 ± 10% V-3~ 50Hz (operating values at 50 Hz)			
	t ₁₁ ± 0 °C DT1 = 8K	t ₁₁ -18 °C DT1 = 7K			Inlet	Outlet		Blade	min ⁻¹	W	A			
SGL(E)	kW	kW	m ²	m ³ /h	m	m	dm ³	Ø mm	Ø mm	Ø mm				
56-F83	⊗⊗⊗	40,0	32,0	177	23100	54	35	66	22	54	560	1338	813	1,78
63-F43	⊗⊗⊗	29,2	23,3	119	27600	63	41	45	22	42	630	919	539	1,38
63-F63	⊗⊗⊗	40,4	32,3	179	27000	63	41	67	22	54	630	919	539	1,38
63-F83	⊗⊗⊗	47,9	38,2	239	26100	63	41	89	28	54	630	919	539	1,38
71-F43	⊗⊗⊗	42,6	34,1	186	38400	73	44	69	28	54	710	940	1140	2,39
71-F63	⊗⊗⊗	59,8	47,8	278	37800	73	44	104	2x22	2x42	710	940	1140	2,39
71-F83	⊗⊗⊗	72,6	58,0	372	37200	73	44	138	2x28	2x42	710	940	1140	2,39
80-F43	⊗⊗⊗	60,6	48,4	217	64800	77	-	81	28	54	800	940	1630	3,46
80-F63	⊗⊗⊗	74,4	59,5	324	62640	77	-	121	2x28	2x54	800	940	1630	3,46
80-F83	⊗⊗⊗	95,8	76,5	432	61560	77	-	161	2x28	2x54	800	940	1630	3,46
50-F44	⊗⊗⊗⊗	24,7	19,8	88	26800	47	31	33	15	42	500	1390	657	1,32
50-F64	⊗⊗⊗⊗	33,9	27,1	132	26000	47	31	50	22	54	500	1390	657	1,32
56-F44	⊗⊗⊗⊗	31,4	25,1	118	32400	56	36	44	22	54	560	1338	813	1,78
56-F64	⊗⊗⊗⊗	43,9	35,1	177	31600	56	36	66	28	54	560	1338	813	1,78
56-F84	⊗⊗⊗⊗	53,4	42,6	236	30800	56	36	88	2x22	2x42	560	1338	813	1,78
63-F44	⊗⊗⊗⊗	38,9	31,1	159	36800	65	42	59	22	54	630	919	539	1,38
63-F64	⊗⊗⊗⊗	53,9	43,0	239	36000	65	42	89	28	54	630	919	539	1,38
63-F84	⊗⊗⊗⊗	63,8	51,0	318	34800	65	42	118	2x22	2x42	630	919	539	1,38
71-F44	⊗⊗⊗⊗	56,9	45,4	248	51200	78	47	92	28	54	710	940	1140	2,39
71-F64	⊗⊗⊗⊗	79,8	63,7	371	50400	78	47	138	2x28	2x54	710	940	1140	2,39
71-F84	⊗⊗⊗⊗	96,8	77,3	496	49600	78	47	184	2x28	2x54	710	940	1140	2,39
80-F44	⊗⊗⊗⊗	80,8	64,5	289	86400	79	-	107	28	64	800	940	1630	3,46
80-F64	⊗⊗⊗⊗	99,2	79,3	432	83520	79	-	161	2x28	2x54	800	940	1630	3,46
80-F84	⊗⊗⊗⊗	127,7	102,0	576	82080	79	-	214	2x28	2x54	800	940	1630	3,46
50-F45	⊗⊗⊗⊗⊗	30,9	24,7	110	33500	52	34	41	22	54	500	1390	657	1,32
50-F65	⊗⊗⊗⊗⊗	42,4	33,9	165	32500	52	34	62	22	54	500	1390	657	1,32
56-F45	⊗⊗⊗⊗⊗	39,3	31,4	148	40500	61	40	55	22	54	560	1338	813	1,78
56-F65	⊗⊗⊗⊗⊗	54,9	43,8	221	39500	61	40	82	28	54	560	1338	813	1,78
56-F85	⊗⊗⊗⊗⊗	66,7	53,3	295	38500	61	40	109	2x22	2x42	560	1338	813	1,78
63-F45	⊗⊗⊗⊗⊗	48,6	38,8	199	46000	71	46	74	22	54	630	919	539	1,38
63-F65	⊗⊗⊗⊗⊗	67,3	53,8	299	45000	71	46	111	28	54	630	919	539	1,38
63-F85	⊗⊗⊗⊗⊗	79,8	63,7	398	43500	71	46	147	2x22	2x54	630	919	539	1,38



Q_v Chart (EN328, R404A)

SGL-F



t_{L1} [°C] Air inlet temperature

Q₀ [kW] Cooling capacity

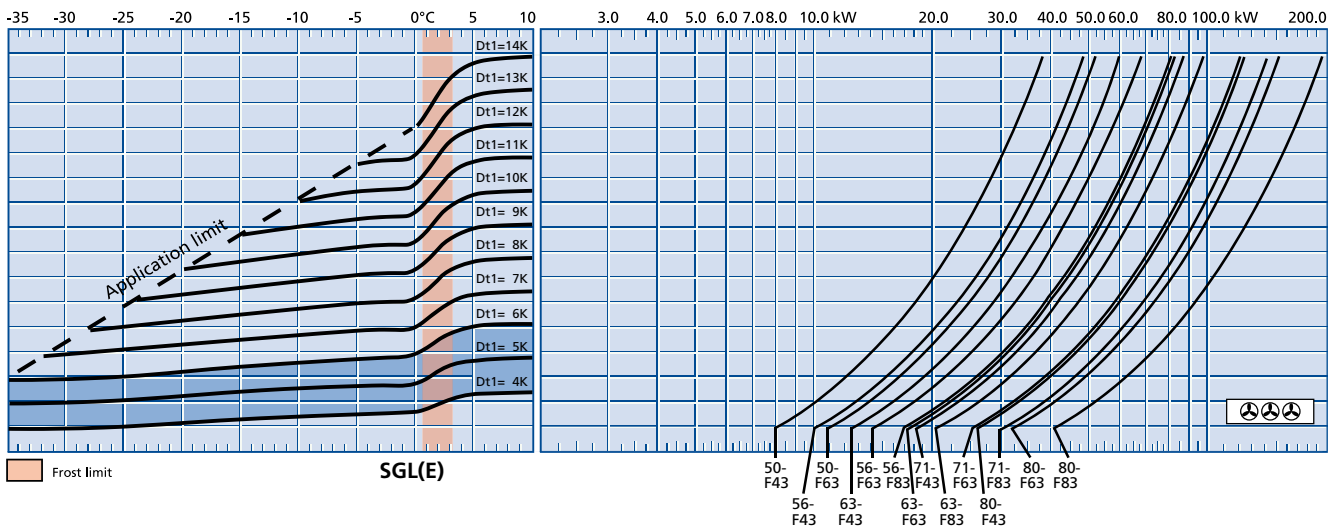
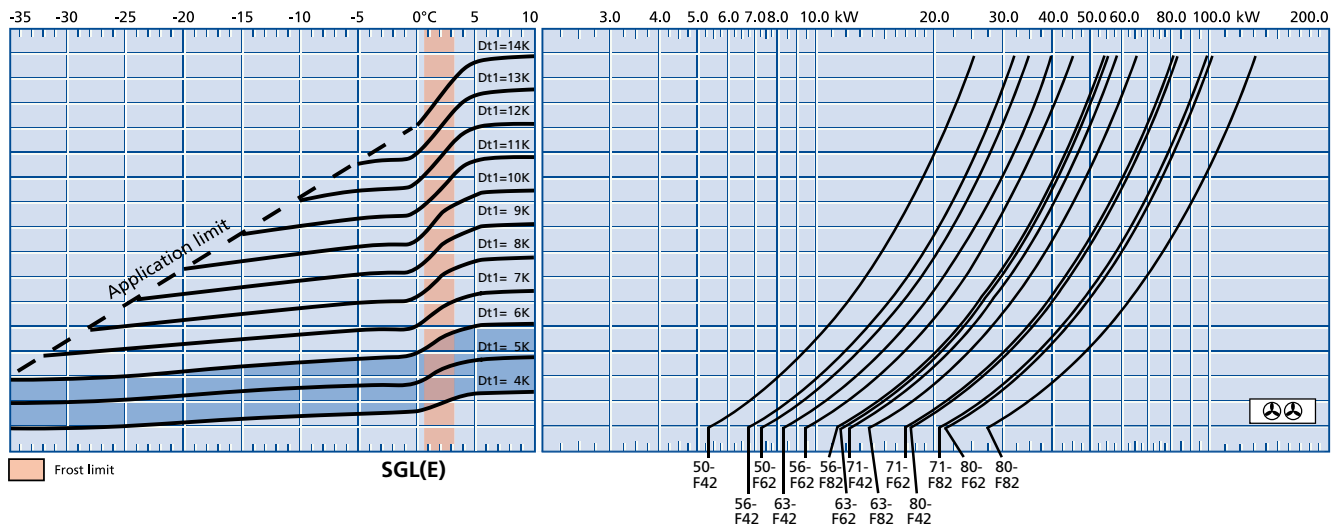
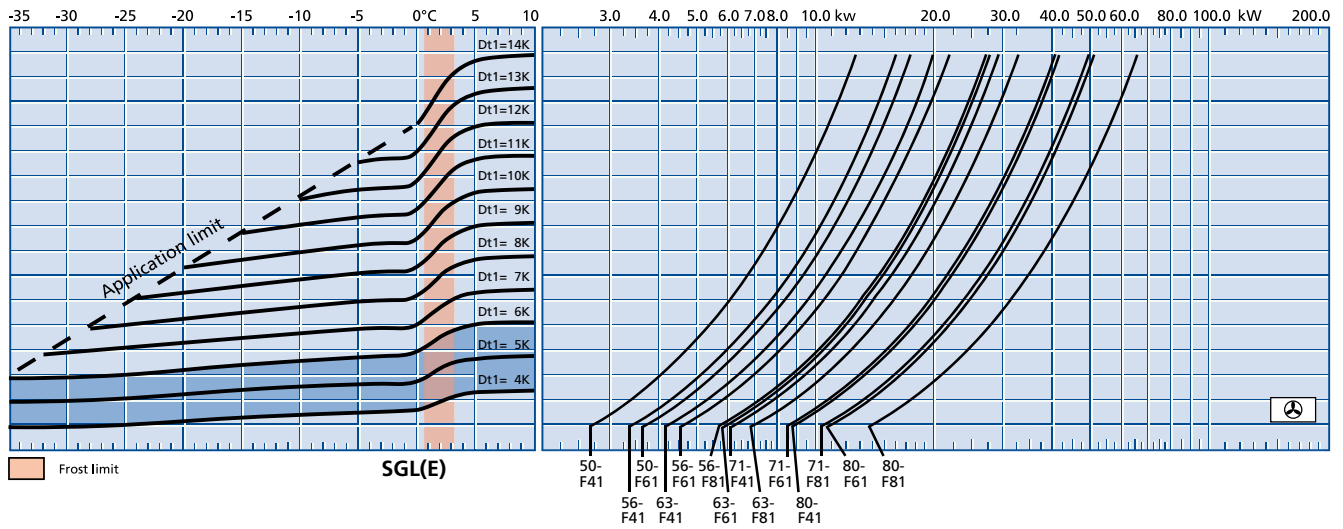

86



Q_v Chart (EN328, R404A) SGL-F  **12 mm**

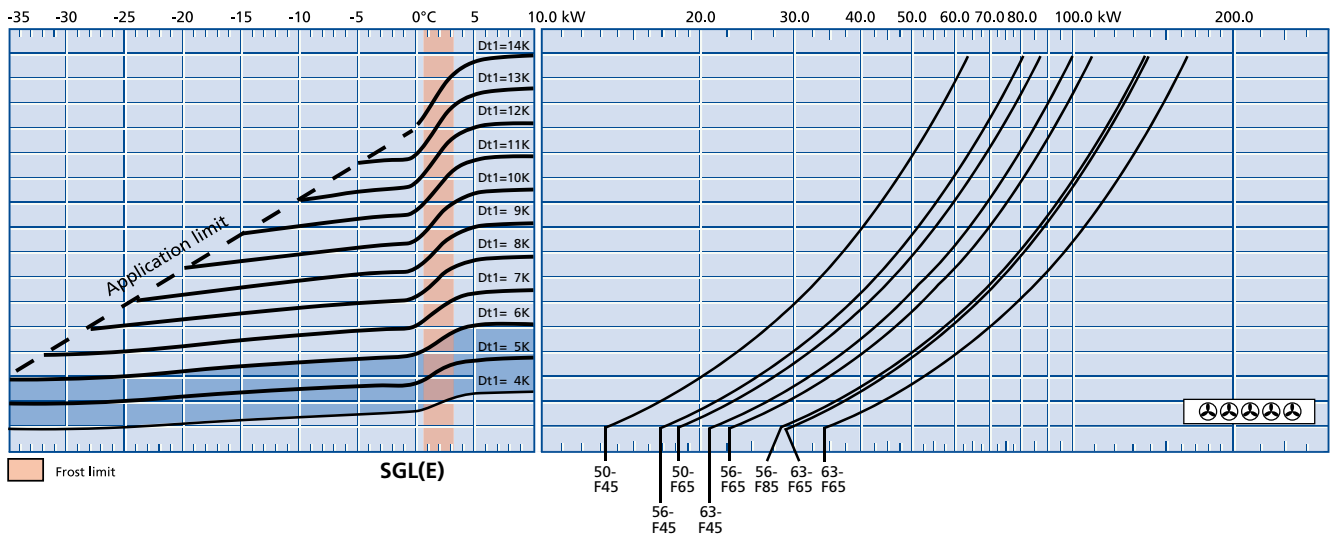
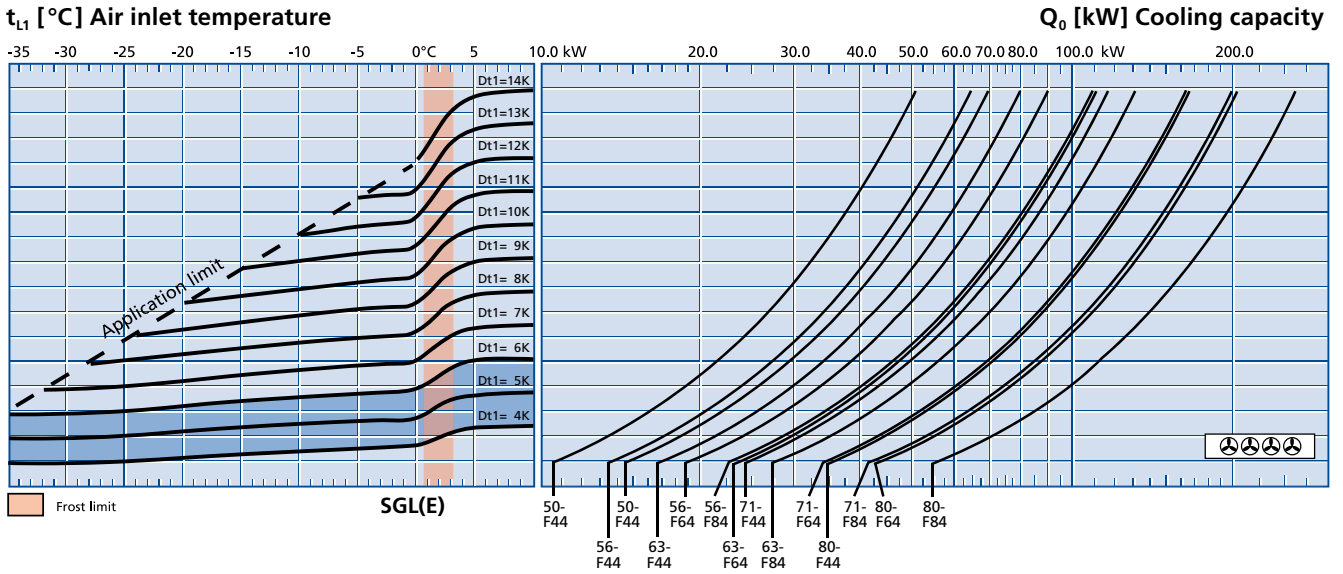

Q₀ = Cooling capacity
 t_{L1} = Air inlet temperature
 t₀ [°C] = Evaporating temperature (coil outlet)
 DT1 [K] = Temperature difference = t_{L1} - t₀ (°C)

DT1 = 4 K bis 6 K
 with electronic expansion valve

For examples and explanations, please see the information section on pg. 136.

Example selection:



Dimensional Drawings

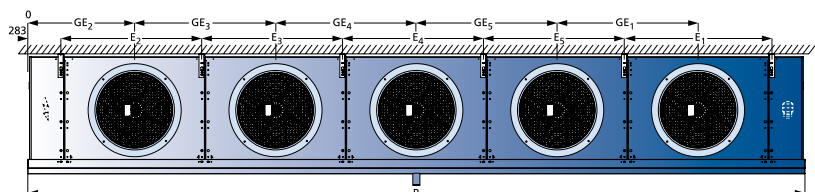
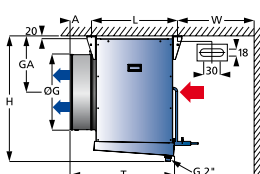
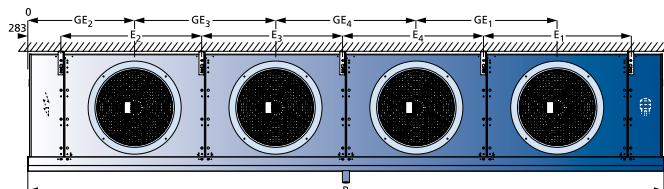
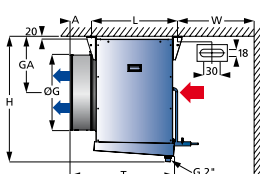
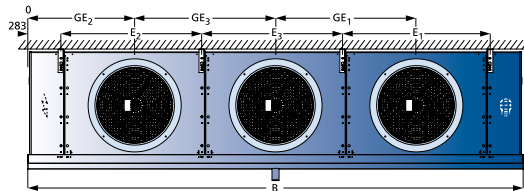
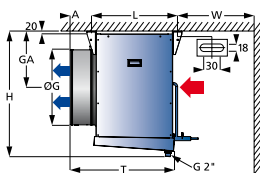
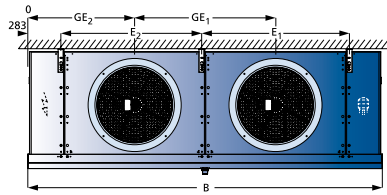
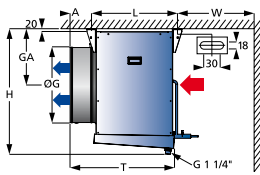
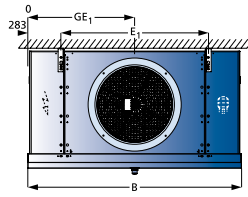
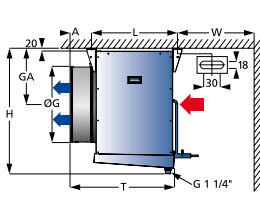

* Note the differences in dimension for accessories!

The dimensions are only valid for the standard model design! When installing fans other than those listed in the „Technical data“, dimensions T and A are larger.

Sound power level L_{WA} [dB(A)]



Model	☪	☪ ☪	☪ ☪ ☪	☪ ☪ ☪ ☪	☪ ☪ ☪ ☪ ☪
SG 50	78	81	83	84	85
SG 56	85	88	90	91	92
SG 63	75	78	80	81	82
SG 70	87	90	92	93	–
SG 80	85	88	90	91	–



Dimensional Drawings, Electric Defrost, Weights

Size	Dimensions [mm]										Electrical defrost						Net weight								
	H	B	T	L	E ₁	E ₂	E ₃	E ₄	E ₅	A	W	W _{min}	ØG	GA	GE ₁	GE ₂	GE ₃	GE ₄	Coil	Tray	Total	SGA	SGB	SGK	SGL
	mm	mm	mm	mm	mm	mm	mm	mm	mm	mm	mm	mm	mm	mm	mm	mm	mm	mm	kW	kW	kW / *	kg	kg	kg	kg
50-41	720	1620	870	704	1054	-	-	-	-	190	500	860	518	329	783	-	-	-	4,78	2,29	7,07/1	130	122	119	117
50-61	720	1620	870	704	1054	-	-	-	-	190	500	860	518	329	783	-	-	-	5,97	2,29	8,26/1	146	139	130	127
56-41	920	1620	870	704	1054	-	-	-	-	190	550	860	576	429	783	-	-	-	6,69	2,29	8,98/1	163	152	149	146
56-61	920	1620	870	704	1054	-	-	-	-	190	550	860	576	429	783	-	-	-	7,96	2,29	10,25/2	185	164	165	163
56-81	920	1620	870	704	1054	-	-	-	-	190	550	860	576	429	783	-	-	-	10,51	2,29	12,8/2	214	192	184	180
63-41	1020	1820	895	729	1254	-	-	-	-	190	600	960	639	479	883	-	-	-	9,16	2,60	11,76/2	205	192	186	182
63-61	1020	1820	895	729	1254	-	-	-	-	190	600	960	639	479	883	-	-	-	10,31	2,60	12,91/2	236	215	208	203
63-81	1020	1820	895	729	1254	-	-	-	-	190	600	960	639	479	883	-	-	-	13,74	2,60	16,34/2	269	241	232	225
71-41	1325	2020	1040	757	1454	-	-	-	-	310	700	1340	734	629	983	-	-	-	14,30	2,87	17,17/2	286	264	257	251
71-61	1325	2020	1040	757	1454	-	-	-	-	310	700	1340	734	629	983	-	-	-	15,60	2,87	18,47/2	334	301	290	281
71-81	1325	2020	1040	757	1454	-	-	-	-	310	700	1340	734	629	983	-	-	-	22,10	2,87	24,97/2	387	343	328	317
80-41	1535	2020	1130	757	1454	-	-	-	-	400	800	1340	804	729	983	-	-	-	16,90	2,87	19,77/2	352	309	301	295
80-61	1535	2020	1130	757	1454	-	-	-	-	400	800	1340	804	729	983	-	-	-	18,20	2,87	21,07/2	401	353	341	331
80-81	1535	2020	1130	757	1454	-	-	-	-	400	800	1340	804	729	983	-	-	-	26,00	2,87	28,87/2	452	400	384	370
50-42	720	2620	870	704	2054	1000	-	-	-	190	500	860	518	329	1783	783	-	-	8,60	3,75	12,35/2	214	199	193	189
50-62	720	2620	870	704	2054	1000	-	-	-	190	500	860	518	329	1783	783	-	-	10,80	3,75	14,55/2	247	223	216	210
56-42	920	2620	870	704	2054	1000	-	-	-	190	550	860	576	429	1783	783	-	-	12,04	3,75	15,79/2	268	247	241	235
56-62	920	2620	870	704	2054	1000	-	-	-	190	550	860	576	429	1783	783	-	-	14,40	3,75	18,15/2	313	282	271	268
56-82	920	2620	870	704	2054	1000	-	-	-	190	550	860	576	429	1783	783	-	-	18,92	3,75	22,67/2	363	321	307	296
63-42	1020	3020	895	729	2454	1200	-	-	-	190	600	960	639	479	2083	883	-	-	16,00	4,33	20,33/2	347	319	310	302
63-62	1020	3020	895	729	2454	1200	-	-	-	190	600	960	639	479	2083	883	-	-	18,00	4,33	22,33/2	410	367	353	342
63-82	1020	3020	895	729	2454	1200	-	-	-	190	600	960	639	479	2083	883	-	-	24,00	4,33	28,33/2	473	416	398	384
71-42	1325	3420	1040	757	2854	1400	-	-	-	310	700	1340	734	629	2383	983	-	-	24,75	4,84	29,59/2	486	441	427	416
71-62	1325	3420	1040	757	2854	1400	-	-	-	310	700	1340	734	629	2383	983	-	-	27,00	4,84	31,84/2	584	516	494	478
71-82	1325	3420	1040	757	2854	1400	-	-	-	310	700	1340	734	629	2383	983	-	-	38,25	4,84	43,09/3	680	592	562	540
80-42	1535	3420	1130	757	2854	1400	-	-	-	400	800	1340	804	729	2383	983	-	-	29,25	4,84	34,09/2	610	523	508	495
80-62	1535	3420	1130	757	2854	1400	-	-	-	400	800	1340	804	729	2383	983	-	-	31,50	4,84	36,34/2	687	608	584	565
80-82	1535	3420	1130	757	2854	1400	-	-	-	400	800	1340	804	729	2383	983	-	-	45,00	4,84	49,84/3	802	696	664	638
50-43	720	3620	870	704	3054	1000	2000	-	-	190	500	860	518	329	2783	783	1783	-	13,00	5,20	18,2/2	302	278	270	264
50-63	720	3620	870	704	3054	1000	2000	-	-	190	500	860	518	329	2783	783	1783	-	15,60	5,20	20,8/2	353	317	306	297
56-43	920	3620	870	704	3054	1000	2000	-	-	190	550	860	576	429	2783	783	1783	-	18,20	5,20	23,4/2	377	345	335	327
56-63	920	3620	870	704	3054	1000	2000	-	-	190	550	860	576	429	2783	783	1783	-	20,80	5,20	26/2	446	399	383	379
56-83	920	3620	870	704	3054	1000	2000	-	-	190	550	860	576	429	2783	783	1783	-	28,60	5,20	33,8/3	519	454	433	417
63-43	1020	4220	895	729	3654	1200	2400	-	-	190	600	960	639	479	3283	883	2083	-	23,84	5,96	29,8/2	490	447	490	422
63-63	1020	4220	895	729	3654	1200	2400	-	-	190	600	960	639	479	3283	883	2083	-	26,82	5,96	32,78/2	583	517	583	481
63-83	1020	4220	895	729	3654	1200	2400	-	-	190	600	960	639	479	3283	883	2083	-	35,76	5,96	41,72/3	679	594	680	544
71-43	1325	4820	1040	757	4254	1400	2800	-	-	310	700	1340	734	629	3783	983	2383	-	37,84	6,88	44,27/3	704	637	701	599
71-63	1325	4820	1040	757	4254	1400	2800	-	-	310	700	1340	734	629	3783	983	2383	-	41,28	6,88	47,64/3	847	746	710	688
71-83	1325	4820	1040	757	4254	1400	2800	-	-	310	700	1340	734	629	3783	983	2383	-	58,48	6,88	64,49/4	999	866	997	790
80-43	1535	4820	1130	757	4254	1400	2800	-	-	400	800	1340	804	729	3783	983	2383	-	44,72	6,88	51,01/3	886	755	732	712
80-63	1535	4820	1130	757	4254	1400	2800	-	-	400	800	1340	804	729	3783	983	2383	-	48,16	6,88	54,38/3	999	880	844	815
80-83	1535	4820	1130	757	4254	1400	2800	-	-	400	800	1340	804	729	3783	983	2383	-	68,80	6,88	74,6/4	1179	1021	973	933
50-44	720	4620	870	704	4054	1000	2000	3000	-	190	500	860	518	329	3783	783	1783	2783	16,85	6,74	22,64/2	375	343	333	325
50-64	720	4620	870	704	4054	1000	2000	3000	-	190	500	860	518	329	3783	783	1783	2783	20,22	6,74	25,82/2	441	393	378	366
56-44	920	4620	870	704	4054	1000	2000	3000	-	190	550	860	576	429	3783	783	1783	2783	23,59	6,74	29/2	470	428	414	404
56-64	920	4620	870	704	4054	1000	2000	3000	-	190	550	860	576	429	3783	783	1783	2783	26,96	6,74	32,18/2	560	497	476	470
56-84	920	4620	870	704	4054	1000	2000	3000	-	190	550	860	576	429	3783	783	1783	2783	37,07	6,74	41,72/3	648	564	536	515
63-44	1020	5420	895	729	4854	1200	2400	3600	-	190	600	960	639	479	4483	883	2083	3283	31,20	7,80	39/3	633	576	558	543
63-64	1020	5420	895	729	4854	1200	2400	3600	-	190	600	960	639	479	4483	883	2083	3283	35,10	7,80	42,9/3	755	670	642	621
63-84	1020	5420	895	729	4854	1200	2400	3600	-	190	600	960	639	479	4483	883	2083	3283	46,80	7,80	54,6/4	883	768	731	703
71-44	1325	6220	1040	757	5654	1400	2800	4200	-	310	700	1340	734	629	5183	983	2383	3783	47,92	8,71	57,2/3	895	806	777	755
71-64	1325	6220	1040	757	5654	1400	2800	4200	-	310	700	1340	734	629	5183	983	2383	3783	52,27	8,71	61,6/4	1084	949	905	872
71-84	1325	6220	1040	757	5654	1400	2800	4200	-	310	700	1340	734	629	5183	983	2383	3783	74,05	8,71	83,6/4	1280	1101	1043	999
80-44	1535	6220	1130	757	5654	1400	2800	4200	-	400	800	1340	804	729	5183	983	2383	3783	56,63	8,71	66/4	1132	958	926	900
80-64	1535	6220	1130	757	5654	1400	2800	4200	-	4															



Versions

Motor versions

Normal refrigeration fan guard
 • V1.07

For certain applications, i.e. in small spaces and quick cooling rooms, the fan guard version is the right solution.

In this version, the design of the fan unit includes a contact safety grille without the Air Guiding Grid and air duct.



For alternative motor versions, see Küba Select or version overview, pg. 130

Water/brine circulation

• V2...
 Tube circuitry and connections for water and brine are available.

Alternative casing versions

Double insulated, hinge-down drip tray 
 • V3.09

The double-shelled drip tray has 25 mm of insulation. The insulation prevents condensation water from building up on the bottom side of the tray and reduces the transfer of defrosting heat into the cold storage area.

This changes the following dimensions:

- Width B: +60 mm
- Height H: +30 mm
- Depth T: +30 mm

Hinged fans

• V3.10



To make the coolers easy to clean, the fans are mounted with stainless steel hinges.

Defrost versions

All GEA Küba Air Coolers are available with electric defrosting. See nomenclature, p. 72

Hot gas defrost in the drip tray

- Hot gas connection on both sides
- V4.01 Copper
- V4.02 Stainless steel



Hot gas in the heat exchanger

- V6.05 Hot gas connection on the heat exchanger



Hot gas in the heat exchanger and in the drip tray, copper design with/without check valve

- Hot gas connection on both sides
- V6.07 with check valve
- V6.08 without check valve

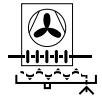
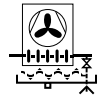

Upon request: additional defrosting circuit: for defrosting with hot gas. A separate circuit for the hot gas is integrated into the heat exchanger.

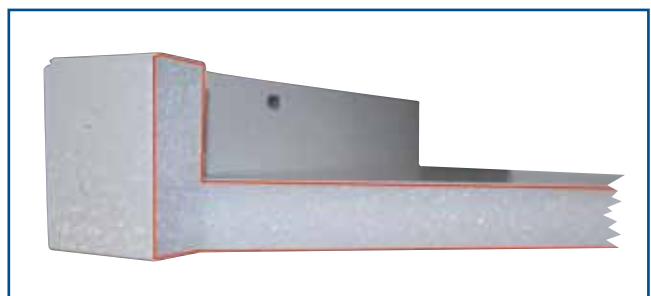



Versions

Protection against corrosion

Stainless steel casing

- V3.12



For protection in aggressive cold storage air, i.e. in smokehouses and curing areas. All casing components are composed of stainless steel and are of industrial quality.

- V6.01



Heat exchanger:

Tubing: Cu
 Fins: Al „goldlack“ coating
 End plates: Al, protective coating

Casing: Sendzimir galvanised steel,
 protective coating on both sides

- V6.02



Heat exchanger:

Tubing: Stainless steel
 Fins: Al „goldlack“ coating
 End plates: Stainless steel

Casing: Sendzimir galvanised steel,
 protective coating on both sides

Refrigerant distributor: Standard Venturi
 Stainless steel CAL® distributor upon request

- V6.03



Heat exchanger:

Tubing: Stainless steel
 Fins: Al
 End plates: Al

Casing: Sendzimir galvanised steel,
 protective coating on one side

Refrigerant distributor: Standard Venturi
 Stainless steel CAL® distributor upon request

- V6.04



Heat exchanger:

Tubing: Cu
 Fins: Al „goldlack“ coating
 End plates: Al

Casing: Sendzimir galvanised steel,
 protective coating on one side



Further information regarding corrosion protection can be found on pages 132 to 135



Accessories

Recommended for frozen storage

- Shut-Up®
- Defrosting hood
- Fan collar heaters
- Duct at 5° incline
- Double insulated drip tray
- Insulate the top panel on site

Shut-Up®

The Küba Shut-Up® optimises the defrosting procedure, especially in deep-freeze applications.

Applications

- Frozen storage starting at -18°C
- Alternating defrosting of the Air Coolers in one room

Advantages (in connection with the defrosting hood)

With Shut-Up® and the defrost hood, a positive accumulation of heat occurs in the Air Cooler during the defrost process. The heat remains in the cooler, which means:

- Defrost times are reduced by more than 50%
- Significant amounts of energy are saved
- No frost build up on the ceiling of the storage room or on the goods due to minimal vapour build-up
- Defrost temperature in the cooler is $\leq 5^{\circ}\text{C}$

Calculation hint

Due to the additional external pressure, the air quantity and Air Cooler capacity change:

Model	Change in air quantity	Change in rating
Küba SG industrial	-10%	-5%

Selection table

for model	Shut-Up®
SG... ☺	1 piece
SG... ☺ ☺	2 pieces
SG... ☺ ☺ ☺	3 pieces
SG... ☺ ☺ ☺ ☺	4 pieces
SG... ☺ ☺ ☺ ☺ ☺	5 pieces

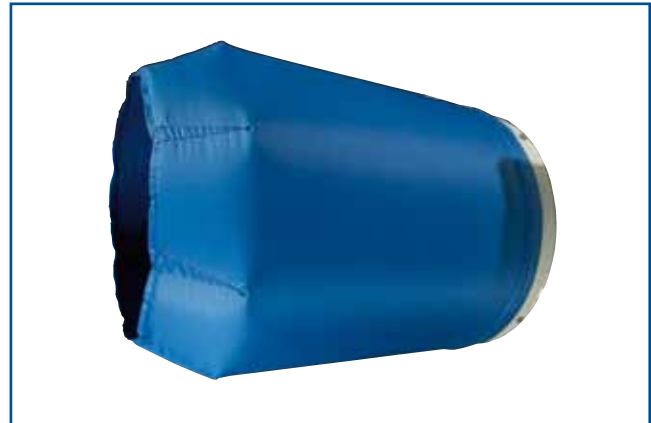

Cooling phase, fans switched on: Shut-Up® is inflated



Defrosting, fans switched off: Shut-Up® closes the Air Cooler

92



Accessories

Defrost Hood

In conjunction with the accessories mentioned on page 92, the defrost hood optimises the defrost process, especially in deep-freeze applications.

Applications

- Frozen storage starting at -18 °C
- Alternating defrosting of the Air Coolers in one room

Advantages (in connection with Shut-Up®)

With the defrost hood and Shut-Up®, a positive accumulation of heat occurs in the Air Cooler during the defrost process. The heat remains in the cooler, which means:

- Defrost times are reduced by more than 50%
- Significant amounts of energy are saved
- No frost build up on the ceiling of the storage room or on the goods due to minimal vapour build-up
- Defrost temperature in the cooler is $\leq 5^{\circ}\text{C}$

Construction

- The double wall drip tray has 12mm of insulation
- The casing is made of aluminium, coated (RAL 9018)
- The construction is modular, i.e. 1 module per fan
- Unassembled upon delivery, so the hoods must be mounted on the Air Cooler on site

Module dimensions and weight:

Model	H mm	B mm	T mm	Weight kg	W _{min.} mm
SG 50..1-5	1080	945	800	33	860
SG 56..1-5	1280	945	800	36	860
SG 63..1-5	1380	1145	900	45	960
SG 71..1-4	1680	1345	1280	61	1340
SG 80..1-4	1880	1345	1280	60	1340

Calculation hint

Due to the additional external pressure, the air quantity and Air Cooler capacity change:

Model	Change in air quantity	Change in cooler rating
SG industrial	-10%	-5%

For deep-freeze applications, GEA Küba engineers recommend an insulated drip tray.

 When using floor brackets, please make sure that you have the correct „defrost hood“.

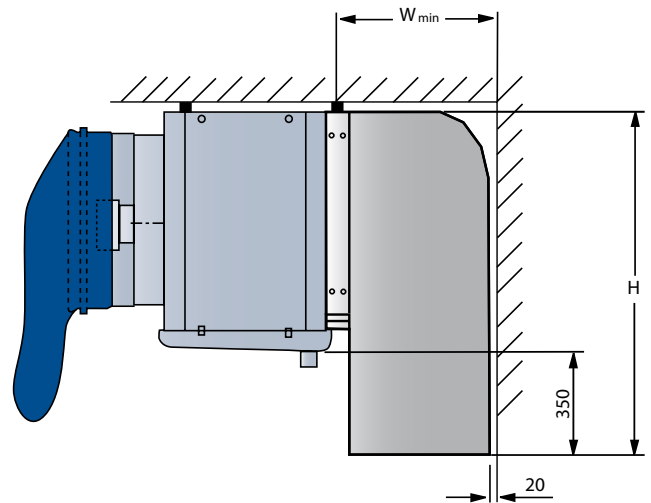

Mode of operation during defrosting: Shut-Up® is suspended over the fan unit, closing the Air Cooler. Hot air cannot escape. The cold air from the room forms a blocking layer on the outside of the defrosting hood.

- Hot air cannot escape
- A chimney effect is prevented

Defrosting process with Shut-Up® and defrost hood

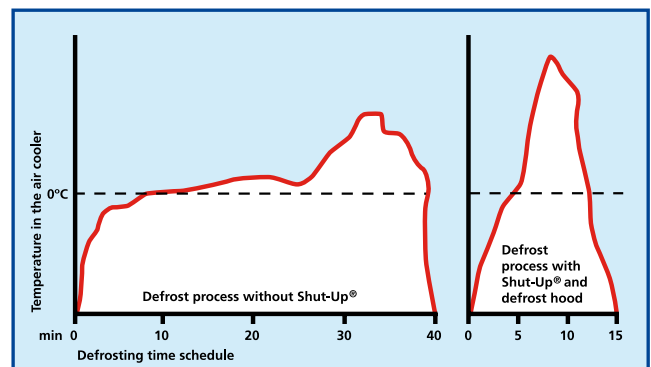

With our deep-freeze package (Shut-Up® and defrosting hood) you will reduce defrosting time by more than half

Fan collar heater VRB

To prevent the fan blade from freezing up at the fan nozzle of the air coolers in extreme humidity conditions in the freezer and frozen storage area.



The standard Küba SG industrial line is suitable for use with fan collar heaters. We recommend using fan collar heaters for applications below 0 °C for version V1 .60 to prevent temperatures from falling below the dew point.



Accessories

Included in delivery:

- Electric tubular heater with stainless steel sleeve
Ø 8.5 mm
- Connection ends: 1.5 x 2000 mm
- Tension spring: stainless steel



Technical Data

Model	For blade Ø mm	P at 230V kW	Weight kg
VRB 50	500	0,27	0,55
VRB 56	560	0,30	0,60
VRB 63	630	0,39	0,65
VRB 71	710	0,38	0,70
VRB 80	800	0,40	0,80

Selection table

for model	VRB
SG... ☺	1
SG... ☺ ☺	2
SG... ☺ ☺ ☺	3
SG... ☺ ☺ ☺ ☺	4
SG... ☺ ☺ ☺ ☺ ☺	5

Fan Collar Heater Cover

Benefits:

- Contact protection
- Reduces heat radiation from the fan collar heaters into the Cold Room
- Improves heat conductivity at the collar
- Increases the efficiency of the fan collar heaters
- Protects against slipping



Can only be used with a metal air duct.



Duct at 5° incline

For complex deep-freeze applications, the duct has a 5° incline to ensure trouble-free operation.

Applications

- Deep-freeze applications at high humidity
- Deep-freeze applications with high-availability, sensitive products (e.g. pharmaceuticals) with few redundant coolers

Advantages

Ventilation ducts with a 5° incline ensures that condensation water runs out of the duct into the drip tray.

- Reduced risk of fan blades at the collar freezing up
- Prevents ice formation on the Air Guiding Grid

Construction

- Ventilation ducts have a 5° inclination toward the casing as well as an integrated air guiding grid
- Ventilation duct is made of Sendzimir galvanised steel plate, coated (RAL 9018)
- Suitable for installation with the Küba Shut-Up® – with no additional accessories necessary

Calculation hint

The ducts positioned at a 5° incline should always be used along with the Shut-Up®, defrosting hoods, fan collar heaters and insulated drip trays.

Floor Mounting Brackets SK

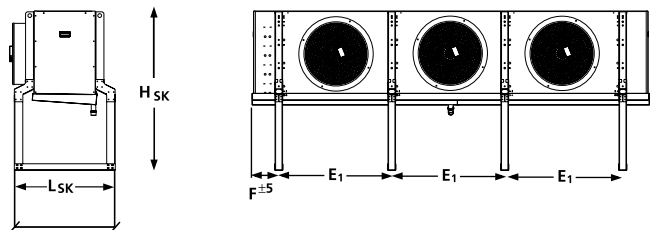

Küba SG		50	56	63	71	80
Dimensions mm	SK	1048	1048	1073	1101	1101
	H _{SK}	1384	1584	1684	1984	2184
	L _{SK}	782	782	807	835	835
	E _{SK}	=E ¹	According Küba SG dimension			
	F	=F	page 89			



Accessories

Finned Tube Heaters SGHR

For Air Coolers with draw through fans, self assembly is required. Air Coolers are suitable for air conditioning or heating in the winter.



Use only with running Air Cooler fans. Failure to do so can cause the ceiling of the cold storage room to overheat. Please observe the respective safety guidelines.

Scope of delivery (unassembled):

- Electric finned tube heater in stainless steel with connection ends: 1,5 x 2000 mm
- Assembly kit including bracket for heater with clamp, connection box IP 54, mounting material

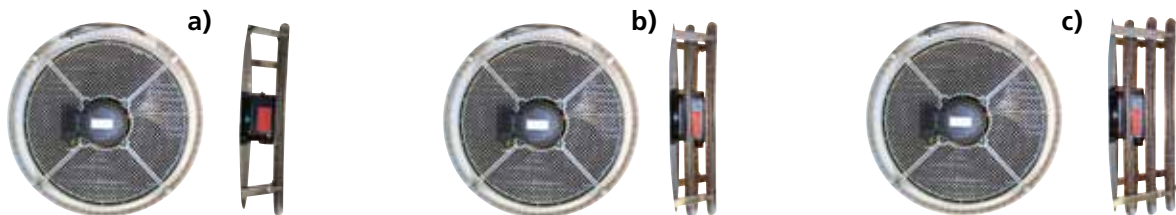

Model	for blade Ø mm	Nominal rating at 230V kW	Weight kg	Model	for blade Ø mm	Nominal rating at 230V kW	Weight kg
SGHR 50	500	3,19	1,13	SGHR 50 Z	500	3,19	1,13
SGHR 56	560	3,51	1,27	SGHR 56 Z	560	3,51	1,27
SGHR 63	630	8,08	2,68	SGHR 63 Z	630	4,04	1,34
SGHR 71	710	9,48	3,23	SGHR 71 Z	710	4,74	1,51
SGHR 80	800	10,5	3,40	SGHR 80 Z	800	5,24	1,70

Selection table

For Air Coolers	Normal heating capacity		Greater heating capacity	
	kW	Number to order	kW	Number to order
SG 50-1	3,19	a) 1 SGHR 50	6,38	b) 1 SGHR 50 + 1 SGHR 50Z
SG 56-1	3,51	a) 1 SGHR 56	7,02	b) 1 SGHR 56 + 1 SGHR 56Z
SG 63-1	8,08	b) 1 SGHR 63	12,1	c) 1 SGHR 63 + 1 SGHR 63Z
SG 71-1	9,48	b) 1 SGHR 71	14,2	c) 1 SGHR 71 + 1 SGHR 71Z
SG 80-1	10,5	b) 1 SGHR 80	15,8	c) 1 SGHR 80 + 1 SGHR 80Z
SG 50-2	6,38	a) 2 SGHR 50	12,8	b) 2 SGHR 50 + 2 SGHR 50Z
SG 56-2	7,02	a) 2 SGHR 56	14,0	b) 2 SGHR 56 + 2 SGHR 56Z
SG 63-2	16,2	b) 2 SGHR 63	24,2	c) 2 SGHR 63 + 2 SGHR 63Z
SG 71-2	19,0	b) 2 SGHR 71	28,4	c) 2 SGHR 71 + 2 SGHR 71Z
SG 80-2	21,0	b) 2 SGHR 80	31,6	c) 2 SGHR 80 + 2 SGHR 80Z
SG 50-3	9,57	a) 3 SGHR 50	19,1	b) 3 SGHR 50 + 3 SGHR 50Z
SG 56-3	10,5	a) 3 SGHR 56	21,1	b) 3 SGHR 56 + 3 SGHR 56Z
SG 63-3	24,3	b) 3 SGHR 63	36,3	c) 3 SGHR 63 + 3 SGHR 63Z
SG 71-3	28,5	b) 3 SGHR 71	42,6	c) 3 SGHR 71 + 3 SGHR 71Z
SG 80-3	31,5	b) 3 SGHR 80	47,4	c) 3 SGHR 80 + 3 SGHR 80Z
SG 50-4	12,8	a) 4 SGHR 50	25,5	b) 4 SGHR 50 + 4 SGHR 50Z
SG 56-4	14,1	a) 4 SGHR 56	28,1	b) 4 SGHR 56 + 4 SGHR 56Z
SG 63-4	32,2	b) 4 SGHR 63	48,4	c) 4 SGHR 63 + 4 SGHR 63Z
SG 71-4	38,0	b) 4 SGHR 71	56,8	c) 4 SGHR 71 + 4 SGHR 71Z
SG 80-4	42,0	b) 4 SGHR 80	63,2	c) 4 SGHR 80 + 4 SGHR 80Z
SG 50-5	15,9	a) 5 SGHR 50	31,9	b) 5 SGHR 50 + 5 SGHR 50Z
SG 56-5	17,6	a) 5 SGHR 56	35,1	b) 5 SGHR 56 + SGHR 56Z
SG 63-5	40,4	b) 5 SGHR 63	60,5	c) 5 SGHR 63 + SGHR 63Z



Accessories

Air Hoses (on site procurement, not available from Küba)

Ventilation can be optimised with textile / PVC air hoses.

Applications

- Applications in work rooms and production areas
- Cooled goods that are sensitive to drafts (i.e. flowers, ripening cheeses)

Advantages

The air hoses make uniform air distribution possible at very low air speeds.

- Working in a draft-free environment yields low illness rates
- Maximum protection for sensitive cooled goods
- No condensation water: temperatures do not fall below the dew point because air can penetrate the woven material

Calculation hints

Please take the respective pressure drop for the cooler design into consideration.

